



Turn on the value of data

HH340/380
Shine 340/380
User Manual



Welcome to become user of Hopeland RFID products.
Thank you for choosing the multi-port reader Shine 340/380,
hope to bring convenience for your work



CONTENTS

1. TECHNICAL SPECIFICATIONS	5
1.1 FEATURES	5
1.2 MAIN FUNCTIONS AND TECHNICAL PERFORMANCE	5
1.2.1 Product Features	5
1.2.2 Typical Applications	5
1.2.3 Specifications	5
2. SKETCH MAP	8
2.1 PHYSICAL CONSTRUCTION	8
2.2 NET WEIGHT	8
2.3 INTERFACE DIAGRAM	8
2.3.1 Power, Communication And I/O Interfaces	8
2.3.2 I/O Interface Definition	9
2.3.3 Coaxial RF Feeder Cable (optional)	12
2.3.4 Network Connection Diagram	12
2.3.5 HDMI Output Description	12
2.3.6 USG OTG Function Description	12
3. INSTALLATION INSTRUCTIONS	13
3.1 PRECAUTIONS	13
3.2 INSTALLATION CONDITIONS	13
3.3 DEVICE CONNECTION	14
3.3.1 Connect Power Adapter Or PoE Switch	14
a. Connect Power Adapter	14
b. Connect PoE Switch	14
3.3.2 Connect External Antenna And RF Cable	15
3.3.3 Connect to PC	15
3.3.4 Install SIM Card	15
3.4 INSTALL READER	16
3.5 ACCEPTANCE	16
3.5.1 Structural Acceptance	16
3.5.2 Performance Acceptance	16
4. ANDROID OS DEMONSTRATION OPERATION	17
4.1 HDMI HIGH-DEFINITION DISPLAY OUTPUT INTERFACE	17
4.2 DISPLAY READER ANDROID OS TO PC VIA SCRCOPY	17
4.3 WIFI SETTINGS	18
4.4 BLUETOOTH SETTINGS	19
4.5 MOBILE NETWORK SETTINGS	22
4.6 RUN ANDROID DEMO	22

5. WEB PAGE OPERATION INSTRUCTIONS.....	25 -
5.1 SYSTEM LOGIN.....	25 -
5.1.1 Login.....	25 -
5.1.2 System Navigation.....	25 -
5.2 RFID SETTINGS.....	26 -
5.2.1 Antenna Configuration.....	26 -
5.2.2 Frequency Configuration.....	27 -
5.2.3 Baseband Configuration.....	27 -
5.2.4 Advanced Baseband Settings.....	28 -
5.3 READER SETTINGS.....	29 -
5.3.1 Ethernet Configuration.....	29 -
5.3.2 Wireless Network Configuration.....	30 -
5.3.3 RS485 Configuration.....	31 -
5.3.4 Advanced Network Parameters.....	32 -
5.4 ADVANCED SETUP.....	32 -
5.4.1 Advanced Setup.....	32 -
5.4.2 Filter Settings.....	33 -
5.4.3 TASK SETTINGS.....	34 -
5.4.3.1 Offline Cache.....	35 -
5.4.3.2 Whitelist.....	35 -
5.4.3.3 Local Tag Log.....	35 -
5.4.3.4 UDP Upload.....	35 -
5.4.3.5 Wiegand Upload.....	35 -
5.4.3.6 HttpPost Upload.....	36 -
5.4.3.7 MQTT Upload.....	37 -
5.4.3.8 MySQL Upload.....	38 -
5.4.3.9 MSSQL Upload.....	40 -
5.4.4 Account Modify.....	43 -
5.5 LOG MANAGEMENT.....	43 -
5.5.1 Operation Log.....	43 -
5.5.2 Tag Log.....	44 -
6. COMMON FAILURES.....	46 -
6.1 DAILY MAINTENANCE.....	46 -
6.2 COMMON FAILURE ANALYSIS AND SOLUTION.....	46 -
7. PACKAGING ACCESSORIES AND STORAGE.....	47 -
7.1 PACKAGE.....	47 -
7.2 ACCESSORIES.....	47 -
7.3 STORAGE REQUIREMENTS.....	48 -
8. AFTER-SALE SERVICE.....	49 -

1. Technical Specifications

1.1 Features

Shine HH340/380 is a high performance four-port/eight-port fixed UHF RFID reader with built-in high-performance Android OS 9. which has strong computing power, large storage capacity, rich interfaces, open development environment, and convenient extension of custom applications. it supports ISO18000-6C/6B protocols. The work frequency includes China standard dual frequency 920MHz~ 925MHz and 840MHz - 845MHz, FCC 902MHz ~ 928MHz and ETSI 865MHz ~ 868MHz.

Output power from 0 ~ 35dBm optional, with long identification distance, fast reading speed, high accurate rate, strong anti-interference ability, good protection performance and easy installation.

1.2 Main Functions And Technical Performance

1.2.1 Product Features

- ✧ Using the Impinj R2000 platform and bi-amplifier synthesis circuitry.
- ✧ Octa-Core processor 4×Cortex-A53 Based 2.3GHZ, 4×Cortex-A53 Based 1.8GHZ;
- ✧ Support protocol: ISO18000-6B/C EPC C1G2
- ✧ Built-in Android 9.0 to facilitate customer customized application development;
- ✧ RJ-45/HDMI/RS-485/OTG/Wiegand port multiple communication interfaces support;
- ✧ Independent mold opening, all aluminum die-casting, efficient heat dissipation;
- ✧ RSSI support: the strength of the signal can be sensed.
- ✧ Antenna detection support
- ✧ Built-in 4G LTE, Bluetooth, WiFi wireless transmission function

1.2.2 Typical Applications

- ✧ Logistics industry such as container operation management, warehouse inventory management, cargo transfer tracking, etc..
- ✧ Intelligent vehicle management e.g. vehicle inspection, customs clearance, vehicle license check, etc..
- ✧ Anti-forgery identification.
- ✧ Production automation, parts flow management, etc.
- ✧ E-ticketing and identification of personnel cards, etc..
- ✧ Power patrol, asset access management, etc.

1.2.3 Specifications

Main Function

Air interface protocol: ISO18000-6B/C EPC C1G2 all mandatory commands

Built-in Android 9.0 operating system

Rich communication interfaces (RJ-45, HDMI, RS-485, OTG, 4G, WiFi, Bluetooth, Wiegand interface)

Adjustable RF output power

POE power supply (optional)

Working mode: fixed frequency/frequency hopping optional

I/O interface: 4 optocoupler inputs, 4 relay outputs (drive capacity: DC 30V/ 2A, AC 125V/0.3A)

Anti-collision protocol, strong multi-tag recognition ability

Support dense reading

Support antenna detection function

Support online upgrade

Support tag data filtering

Support RSSI: senses the strength of the signal

Performance Parameters

Working frequency: GB, 920MHz ~ 925MHz, 840MHz ~ 845MHz; FCC, 902MHz ~ 928MHz; ETSI, 865MHz~868MHz; JPN, 916MHz~920MHz

RF output power (port): 35dBm ± 1dB (MAX)

Output power adjustment: 1 dB step

Channel occupied bandwidth: <200KHz

Frequency stability: $\leq \pm 10\text{ppm}$

Reading distance: 0m ~ 20m (related to factors such as transmitting power, antenna type, tag type and application environment)

Writing distance: 0m ~ 10m (related to factors such as transmitting power, antenna type, tag type and application environment)

Tag recognition speed: >400 times/sec

Network interface communication rate: 10M/100M adaptive

Communication Interfaces

HDMI interface: adaptive resolution (up to 4K);

Ethernet interface: 10M/100M Ethernet interface

RS485 interface: the default baud rate is 115200bps

4G: Support LTE-FDD (CAT-7)/LTE-TDD (CAT-7)/WCDMA/TD-SCDMA/EVDO/CDMA/GSM and other standards

WiFi: 802.11 a/b/g/n/ac

BT: BT v2.1+EDR, 3.0+HS, v4.1+HS

USB interface: support OTG, Type-C

I/O interfaces: 4 relay outputs/4 optocoupler inputs

RF interface: four/eight TNC antenna interfaces

Power Parameters

Equipment power supply: DC 9V~30V (60W);

POE: IEEE802.3af/at/bt standard (optional)

Working power consumption: 30W (output power 35dBm)

Environmental Parameters

Working temperature: -20°C~+70°C

Storage temperature: -40°C~+85°C

Working humidity: 10%~95%RH without condensation

Compliance With Certification

Compliant with China Radio Model Approval

Meet FCC and CE testing standards

2. Sketch map

2.1 Physical construction

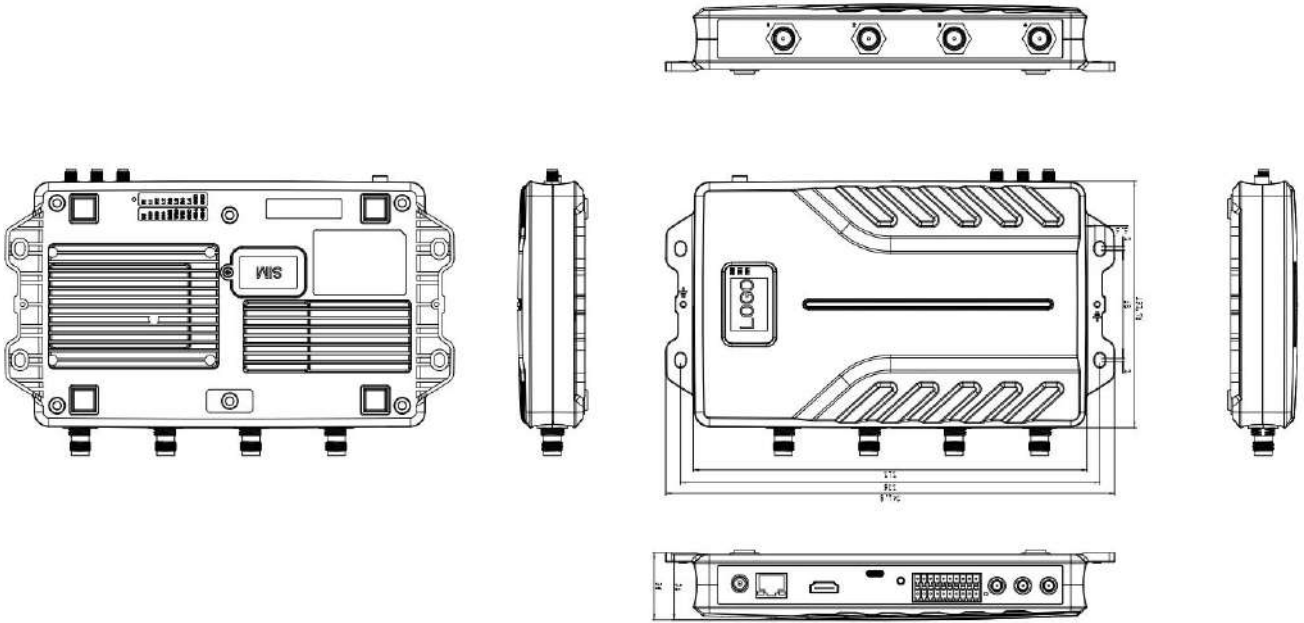

Picture 2-1 Structure diagram of Shine 340/380 reader

Shine 340/380 Reader Volume Parameter is:

241mm×132mm×36mm

2.2 Net Weight

HH340: 0.9kg

HH380: 1kg

2.3 Interface Diagram



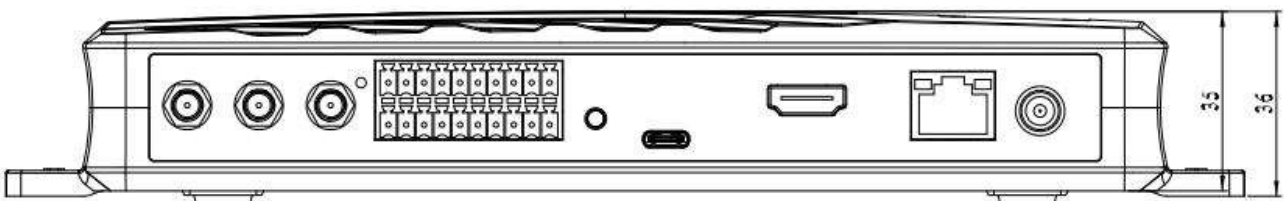

2.3.1 Power, Communication And I/O Interfaces

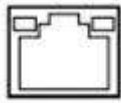

Picture 2-3 Schematic diagram of reader power, communication and I/O interfaces

Picture 2-3 is a schematic diagram of the reader and the power supply, communication and I/O interface panel. For details, see Table 2-2.

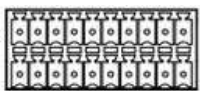
Table 2-2 Reader power supply, communication and I/O interfaces

Interface ID	Interface Name	Detailed Description
	Power supply interface	DC, 10~30V, power capacity not less than 30W.
	Ethernet interface	10/100M Ethernet interface, reader control and communication interface. POE:IEEE802.3af/at/bt standard (optional)
	HDMI output	HDMI signal output 720P with audio.
	USB interface	The USB TYPE-C interface can be connected to a computer and supports OTG.
	I/O interface	See 2.3.2 for detailed definition
	Antenna (optional)	The left one is WIFI, Bluetooth antenna (shared), the middle and right one are 4G antennas
	Reset button	Long press for 3 seconds to restart, long press for 10 seconds to restore factory settings

2.3.2 I/O Interface Definition

Upper Row:

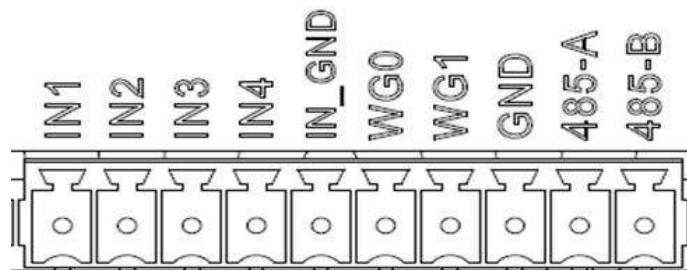

Bottom Row:

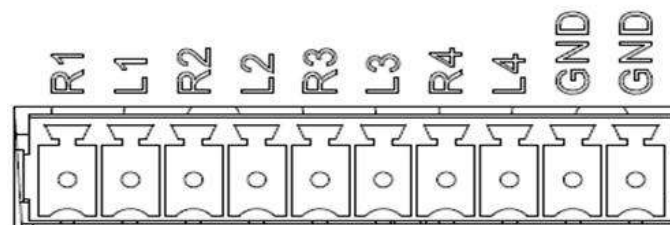

I/O control signal definitions are shown in Table 2-3:

Table 2-3 I/O control interface signal function definition

Pin ID	Pin Description
R1	Relay 1# output; DC_MAX: 30V, 2A; AC_MAX: 125V, 0.3A; logic '0' indicates open circuit,

	logic '1' indicates closed, default is open circuit.
L1	Relay 1# output; DC_MAX: 30V, 2A; AC_MAX: 125V, 0.3A; logic '0' indicates open circuit, logic '1' indicates closed, default is open circuit.
R2	Relay 2# output; DC_MAX: 30V, 2A; AC_MAX: 125V, 0.3A; logic '0' indicates open circuit, logic '1' indicates closed, default is open circuit.
L2	Relay 2# output; DC_MAX: 30V, 2A; AC_MAX: 125V, 0.3A; logic '0' indicates open circuit, logic '1' indicates closed, default is open circuit.
R3	Relay 3# output; DC_MAX: 30V, 2A; AC_MAX: 125V, 0.3A; logic '0' indicates open circuit, logic '1' indicates closed, default is open circuit.
L3	Relay 3# output; DC_MAX: 30V, 2A; AC_MAX: 125V, 0.3A; logic '0' indicates open circuit, logic '1' indicates closed, default is open circuit.
R4	Relay 4# output; DC_MAX: 30V, 2A; AC_MAX: 125V, 0.3A; logic '0' indicates open circuit, logic '1' indicates closed, default is open circuit.
L4	Relay 4# output; DC_MAX: 30V, 2A; AC_MAX: 125V, 0.3A; logic '0' indicates open circuit, logic '1' indicates closed, default is open circuit.
GND	Ground
GND	Ground
IN1	Optocoupler 1# input, DC, 0~24V, higher than 1V is high level, lower than 1V is low level
IN2	Optocoupler 2# input, DC, 0~24V, higher than 1V is high level, lower than 1V is low level
IN3	Optocoupler 3# input, DC, 0~24V, higher than 1V is high level, lower than 1V is low level
IN4	Optocoupler 4# input, DC, 0~24V, higher than 1V is high level, lower than 1V is low level
IN_GND	Optocoupler input ground, reader optocoupler external input signal ground
WG0	Wiegand data 0 signal, the default state is high level
WG1	Wiegand data 1 signal, the default state is high level
GND	Ground
485-A	RS485 A signal
485-B	RS485 B signal

GPI Usage Example:

Infrared sensor type selection: Choose PNP NO type, which means that the infrared is normally low, when the object is detected, the signal line outputs a positive voltage signal.

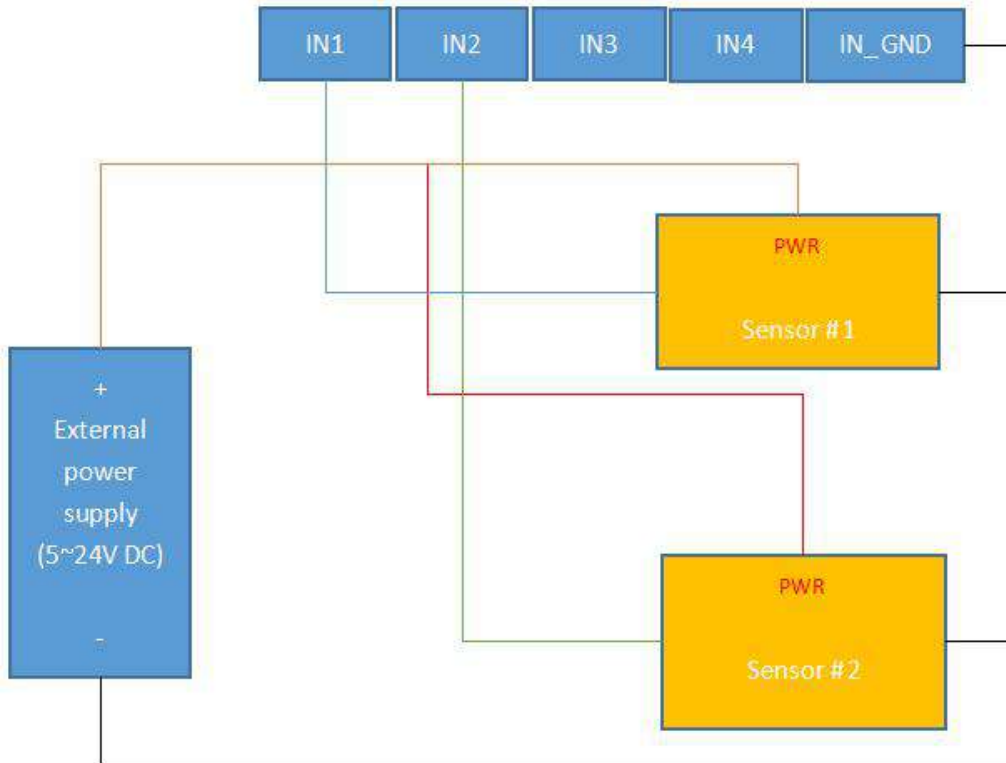

GPO Usage Example:

Relay type GPO: GPO is equivalent to a switch, logic '0' means open circuit, logic '1' means closed, default is open circuit state. You can connect the alarm light, buzzer, etc. to the GPO for use. The usage is shown in the following figure.

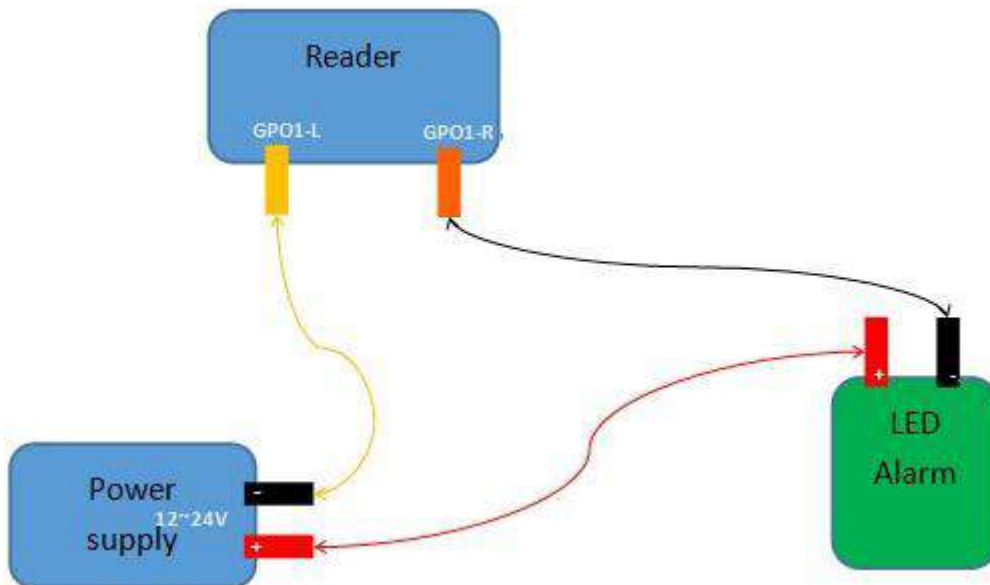

Wiegand Connection Instructions:

Connect reader Wiegand 0 to Wiegand 0 of controller,
 connect reader Wiegand 1 to Wiegand 1 of controller,
 connect reader GND to Wiegand controller GND

2.3.3 Coaxial RF Feeder Cable (optional)



Picture 2-6 schematic diagram of feeder line

RF cable TNC(Reverse polarity, internal thread, inner pin) connector connect with reader antenna TNC connector, RF cable SMA connector connect with external circular polarization antenna's SMA connector, cable maximum length is 5m, impedance 50Ω, insertion loss is less than 2dB, high-performance cable can also be selected, and the length can be increased appropriately, insertion loss is less than 2dB.

Note: Poor contact of cable connector or an ultra-long RF cable can cause excessive attenuation of the transmitted signal and received echo signal, resulting in deterioration of read/write performance.

2.3.4 Network Connection Diagram

The network interface is used for long-distance high-speed connection (not greater than 80 m). It can be connected to a switch or router via a network cable, or it can be directly connected to a PC network interface. The specific connection is shown in Figure 2-7:

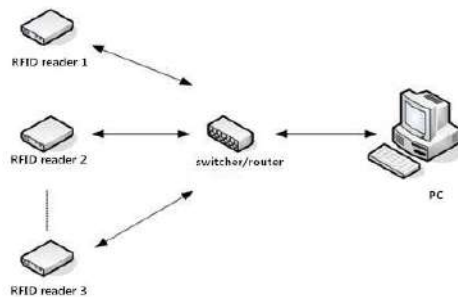

Figure 2-7 Network application connection

2.3.5 HDMI Output Description

The HDMI output signal defaults to 720P (1280*720). Display devices with a resolution lower than 720P may display incomplete or no display.

HDMI has audio output. If you need audio playback, you can expand the audio playback device on the HDMI display terminal or choose a display device with audio playback function.

2.3.6 USG OTG Function Description

USB OTG currently supports keyboard, mouse, touch screen and USB storage devices, and more mobile devices can be supported through the system update.

The USB OTG supports external USB HUB, and the above devices can be used at the same time.

3. Installation Instructions

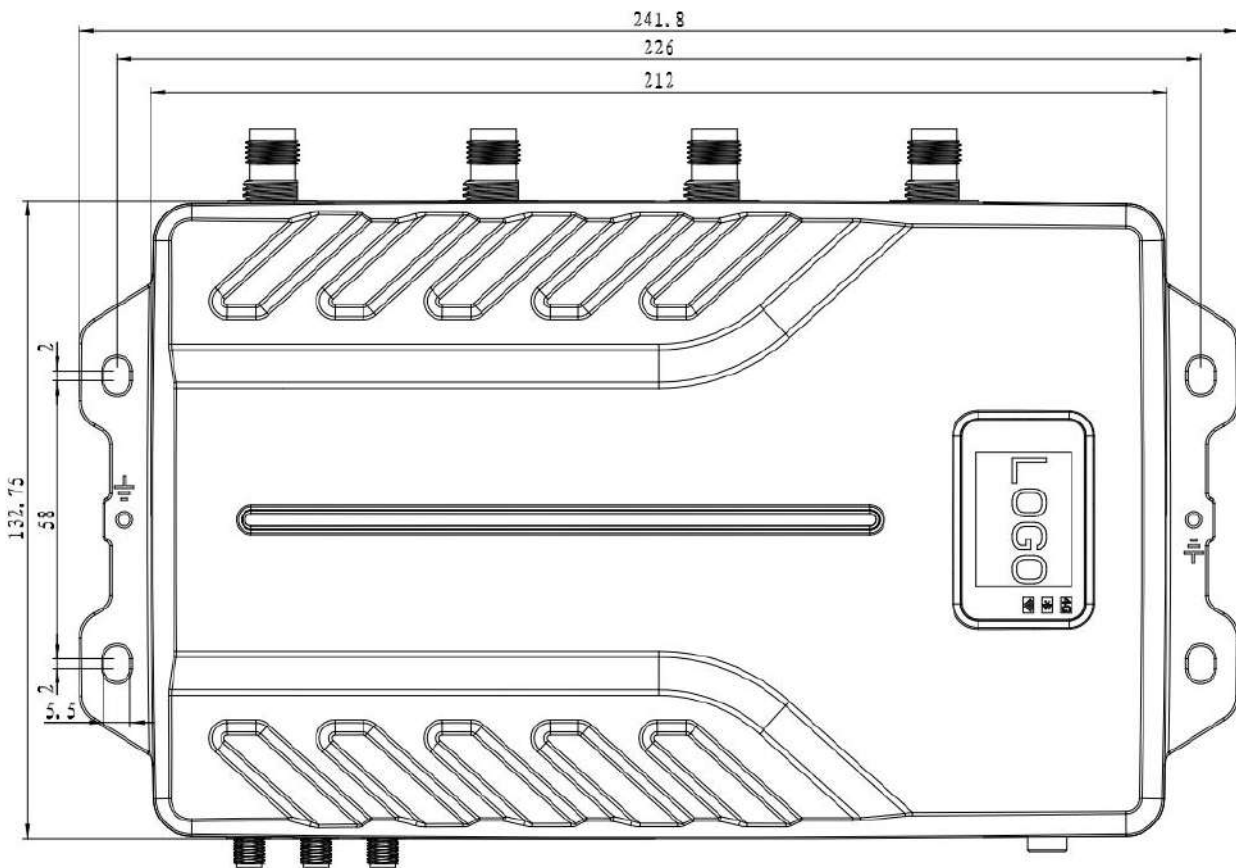

3.1 Precautions

To ensure the normal and stable operation of the device and your personal property and safety, please carefully read the following notes before install HH340/380 reader.

1. Firstly, check whether the power socket is connected to the ground, and to see whether the local power supply voltage is in accordance with the applicable voltage range of the reader;
2. Check the device and the external connection if is closely connected;
3. Pay attention to the type selection and the length limit of the network cable and the serial cable:
 - Network cable connects directly, no longer than 80 meters
 - Serial cable connects directly, no longer than 10 meters
4. When installing several readers, the antenna position and the antenna spacing should be appropriate to avoid interference with each other.

3.2 Installation Conditions

Before installing the reader, please check carefully whether the product is in good condition and the accessories are complete. If there is any parts missing or damage, please contact the supplier in time.

3.3 Device Connection

3.3.1 Connect Power Adapter Or PoE Switch

a. Connect Power Adapter

- ✧ Plug the power cord into the AC power supply outlet and then plug the other end of the power cord into the power connector of the reader and fasten it.
- ✧ Power on the reader, wait for about 10 seconds, the system completes the initialization process and enters the standby state.

b. Connect PoE Switch

A complete PoE system includes two parts: Power Sourcing Equipment (PSE) and Powered Device (PD). PoE switches are PSE devices, and readers are PD devices. According to the power consumption required by the reader, it belongs to 802.3at class 4 or 802.3bt class 5 devices.

Choose the PoE switch according to the maximum output power of the reader that needs to be used in the actual project.

0dBm to +35.0dBm (PoE++)

0dBm to +33dBm (PoE+)

PD Classes:

IEEE802.3af(PoE) include Class 0~3, IEEE802.3at (PoE+)include Class 4,

IEEE802.3bt(POE++) include Class 5 ~ 8

Class	PD available power	Class	PD available power
0	13W	5	40W
1	3.84W	6	51W
2	6.49W	7	62W
3	13W	8	71W
4	25.5W		

PoE protocols supported by various network cables:

	PoE(AF)	PoE+(AT)	PoE++(BT)
CAT 5E	√	√	
CAT 6	√	√	
CAT 6A UTP	√	√	
CAT 6A FTP	√	√	

CAT 7 S/FTP	√	√	√
CAT 7A S/FTP	√	√	√
CAT 8.2 S/FTP	√	√	√

3.3.2 Connect External Antenna And RF Cable

The reader built with four/eight TNC coaxial cable connectors for connecting external antennas, select low consumption RF cable, connectors should be tightened (Ensure to be waterproof when install outdoors);

The reader antenna angle or tilt need to adjust to the best position through the actual test according to the specific application.

3.3.3 Connect to PC

- ✧ The reader is supplied with different dedicated connection cables for the network, USB and power interfaces.
- ✧ USB interface is used for short-distance communication (not greater than 2m), directly connected to the PC USB interface through a USB TYPE-C cable to realize the communication between the PC and the reader;
- ✧ The RJ45 network port is used for long-distance communication (not greater than 80m), and an extended network cable can be used to connect to a PC.

3.3.4 Install SIM Card

- ✧ When you need to use mobile data services, please purchase a Subscriber Identity Module (SIM) card.
- ✧ Remove the cover of the SIM card slot.

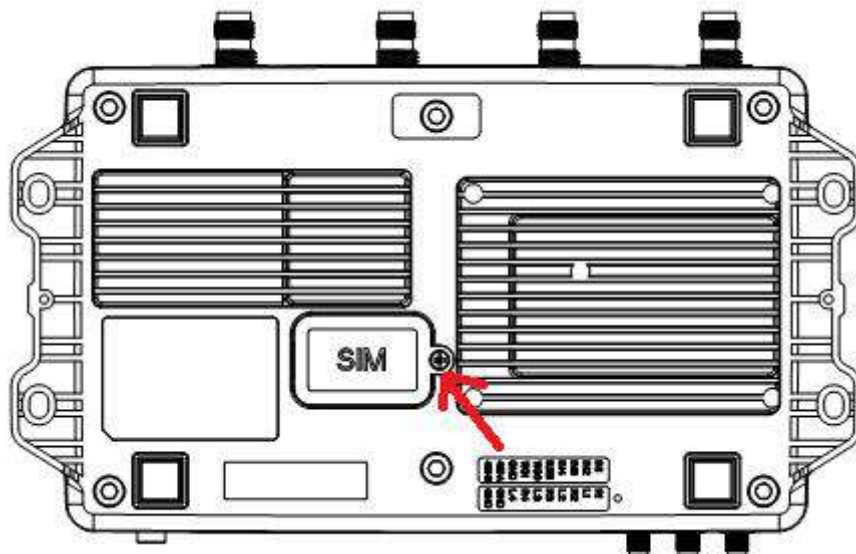

- ✧ Lift the SIM card slot and insert the SIM into the slot so that its gold contacts are facing down, place the SIM card fully in the card holder, and return it to its initial position.

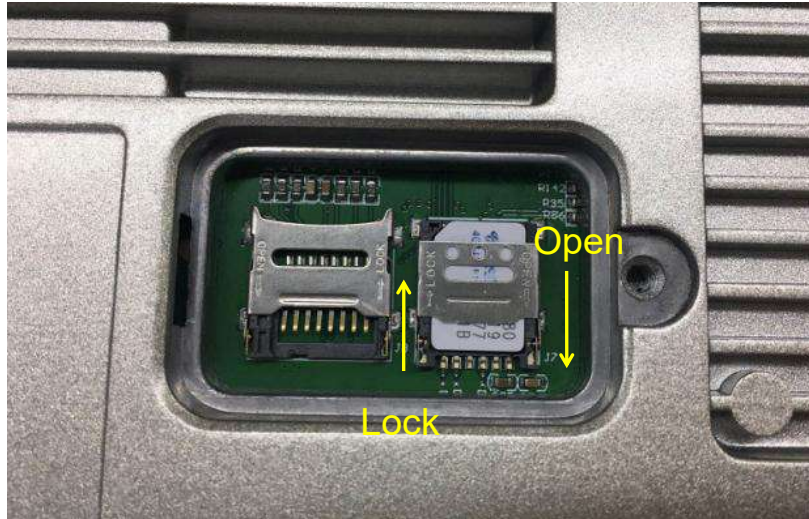

◇Re-install the cover of the SIM card slot.

3.4 Install Reader

The reading and writing range of the reader depends on the onsite application, the tilt angle of the antenna is adjusted to achieve the best reading and writing performance.

3.5 Acceptance

The acceptance criteria are mainly given from two aspects: structure and performance.

3.5.1 Structural Acceptance

- ◇Whether the reader is fixed firmly without looseness;
- ◇Whether the cables are connected firmly;
- ◇Whether the screws are tightened.

3.5.2 Performance Acceptance

- ◇Whether the reader is working normally;
- ◇Whether the reading range is reasonable.

4. Android OS Demonstration Operation

4.1 HDMI High-definition Display Output Interface

HH340/380 is equipped with an HDMI high-definition display output interface. In workstation application scenarios, an external monitor can be connected to operate the reader, or software development on the reader



4.2 Display Reader Android OS to PC via Scrcpy

Using Scrcpy on a PC to display Reader Android OS on a PC. You can download Scrcpy through the link below or search and download by yourself.

Link 1: <https://pan.baidu.com/s/1p3RHvKb4YgGV11WaG7fNzg> Extraction code: 2121

Link 2: https://drive.google.com/file/d/11141-IBK_JWTJJvsBqw0_aAFSumwrRm/view?usp=sharing

1. After the reader is turned on, first connect the PC and the reader type C interface through the supplied USB cable
2. Open the folder of the Scrcpy software, double-click scrcpy.exe to execute the Scrcpy software

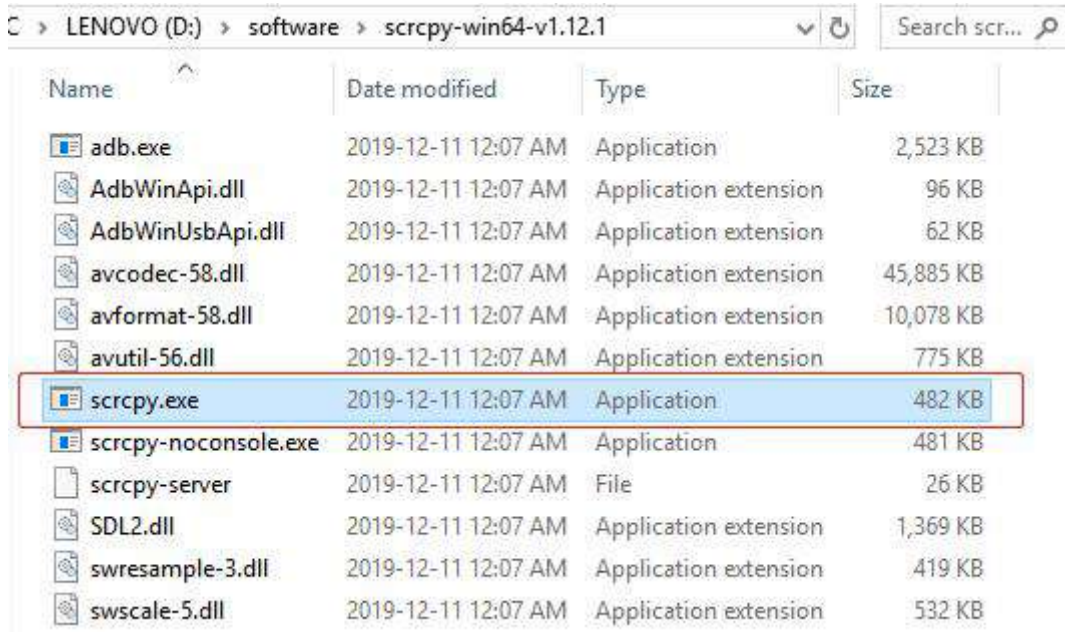

3. Operate the reader OS through the same screen interface

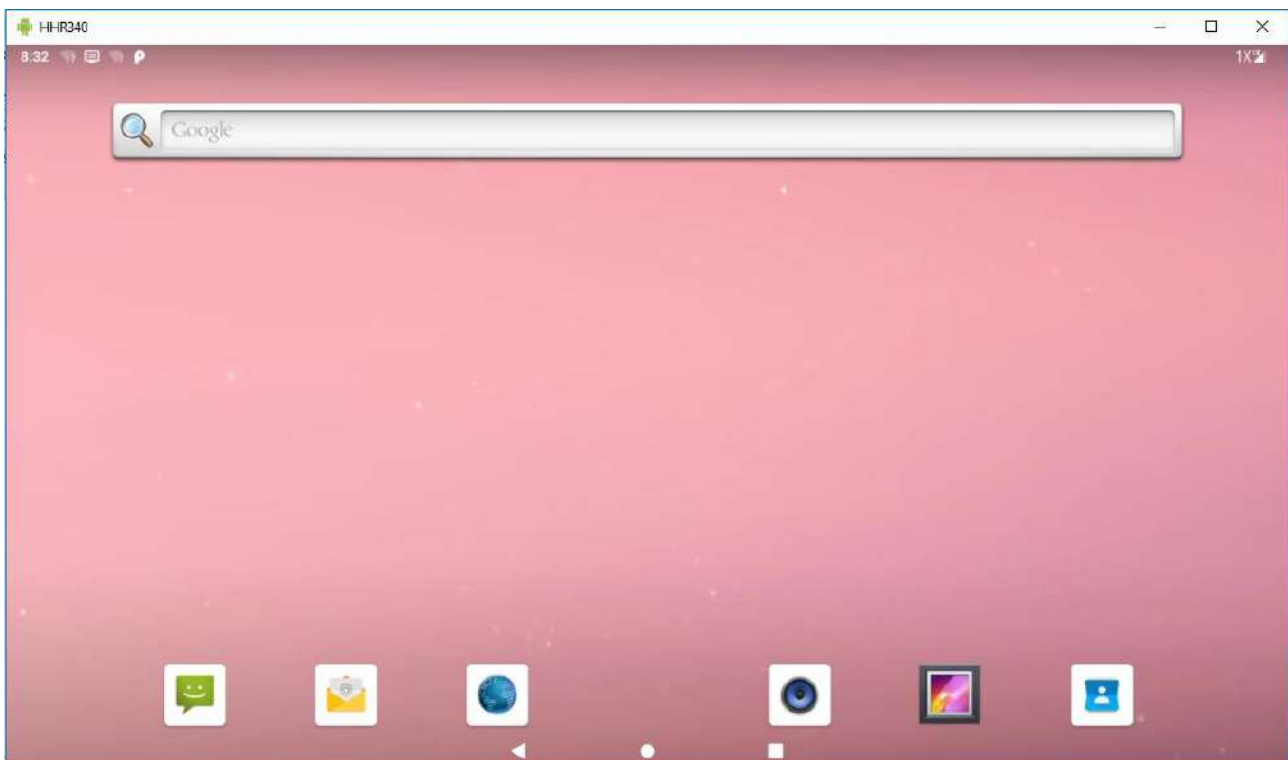

4.3 WiFi Settings

Shine series readers have a built-in WiFi module. You can set WiFi parameters through the Demo software, or you can set the WiFi parameters through the Android OS.

1. After the reader is powered on, connect the supplied WiFi/Bluetooth shared antenna to the reader's WiFi/Bluetooth shared antenna interface



2. Enter the WiFi setting interface of the Android OS, select the WiFi hotspot to connect to, and remember the obtained ip address after connected, and then you can use this ip to connect to the reader through the demo software.

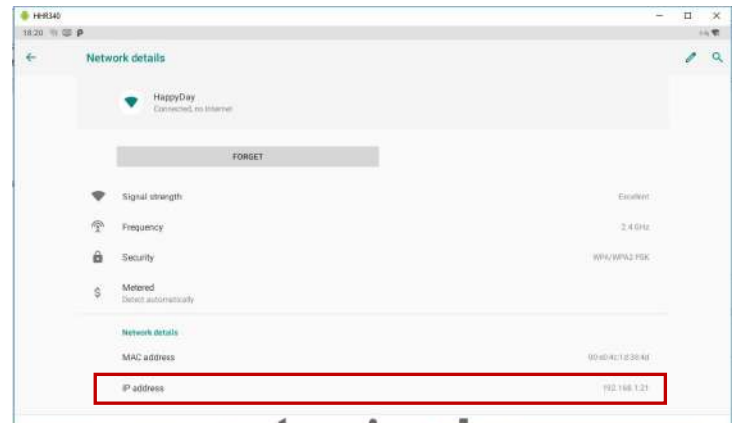
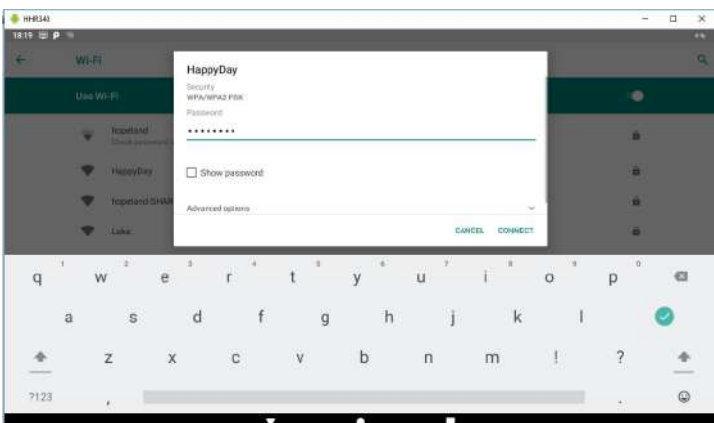
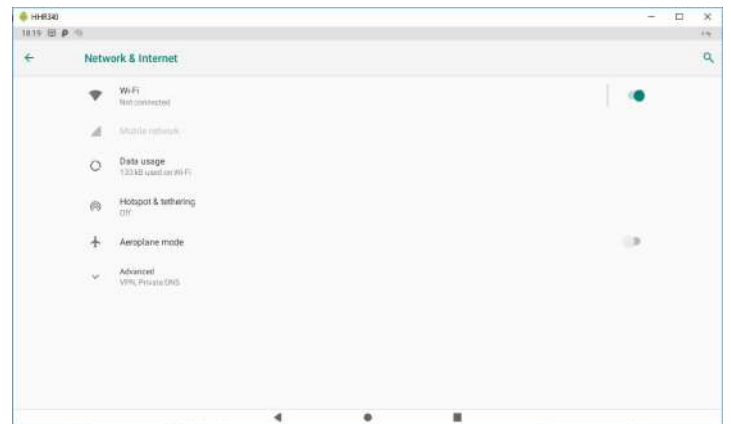
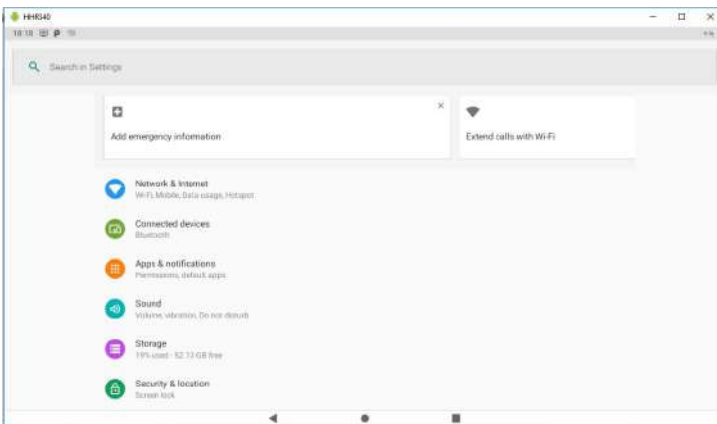

4.4 Bluetooth Settings

Shine series readers have a built-in Bluetooth module, which can be paired with the reader's Bluetooth through a PC. After the Bluetooth serial port is generated, the Demo software can

use this Bluetooth serial port to communicate with the reader.

1. After the reader is powered on, connect the supplied WiFi/Bluetooth shared antenna to the reader's WiFi/Bluetooth shared antenna interface
2. View the Bluetooth name of the reader through the Android OS

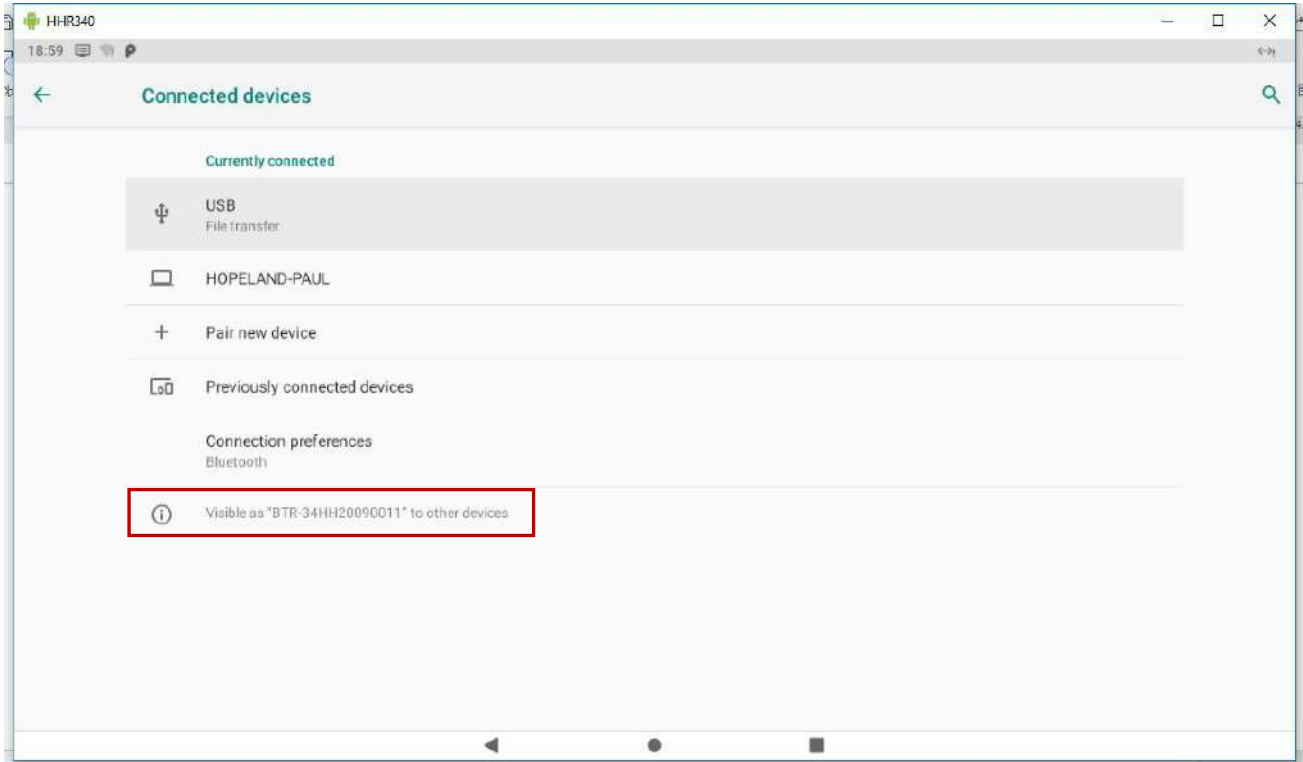

3. Pair the Bluetooth name with the PC system. After the pairing is completed, check the Bluetooth serial port generated between the PC and the reader's Bluetooth. The port with outgoing direction, which is the Bluetooth serial port number that the demo can use for communication.

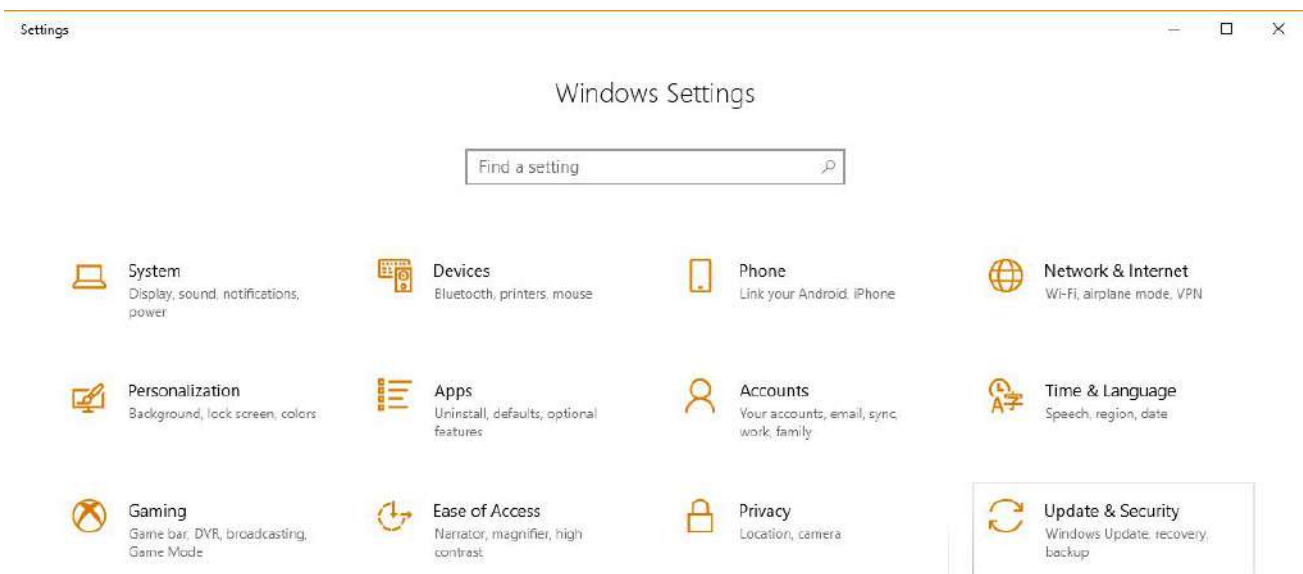

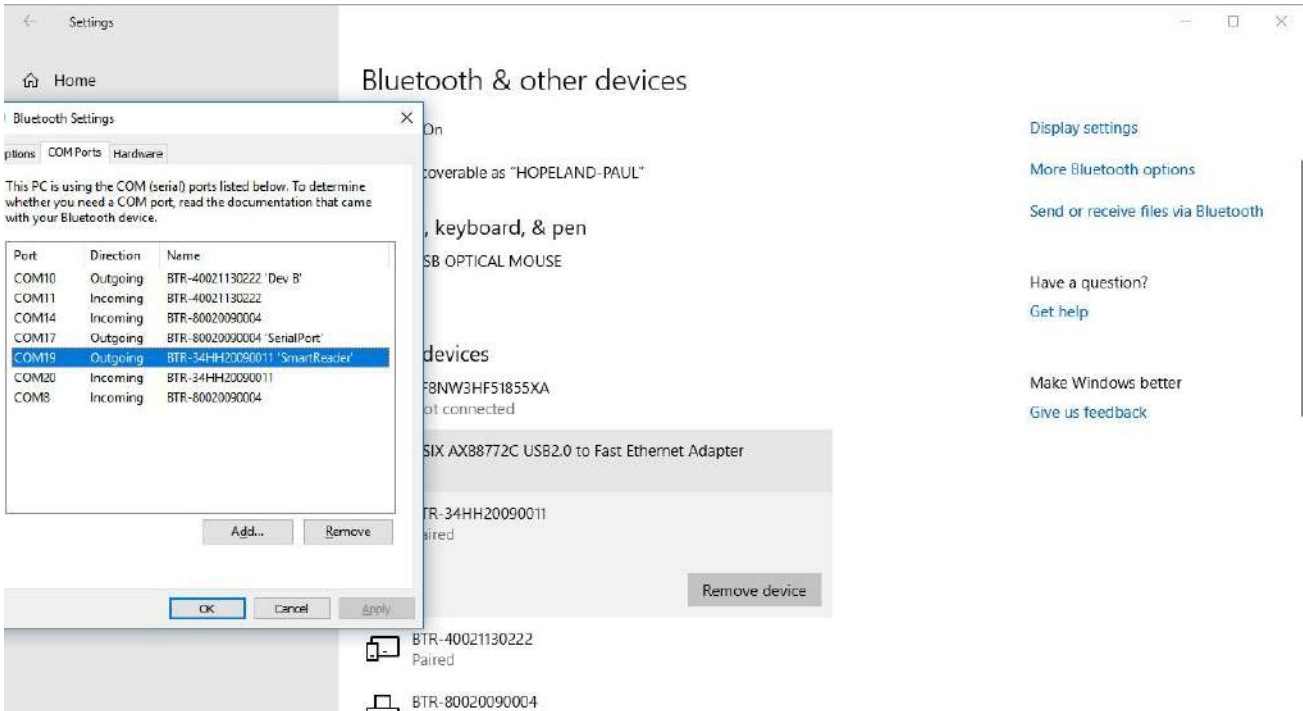
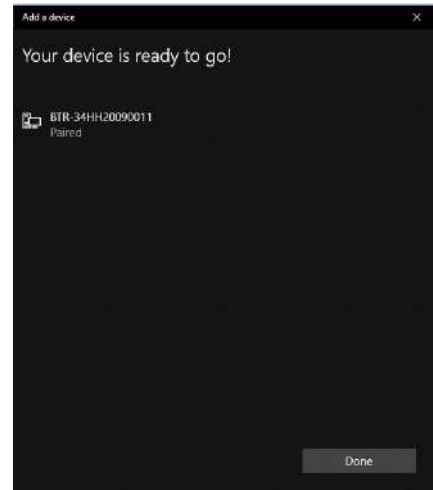
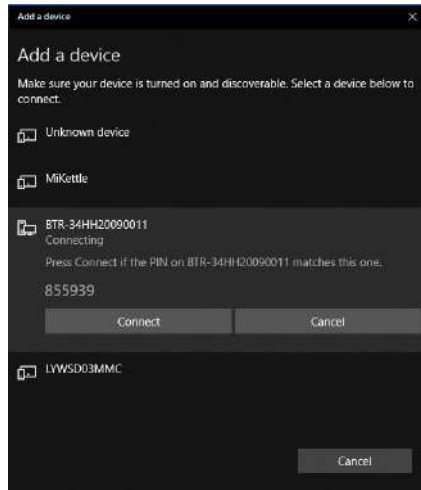
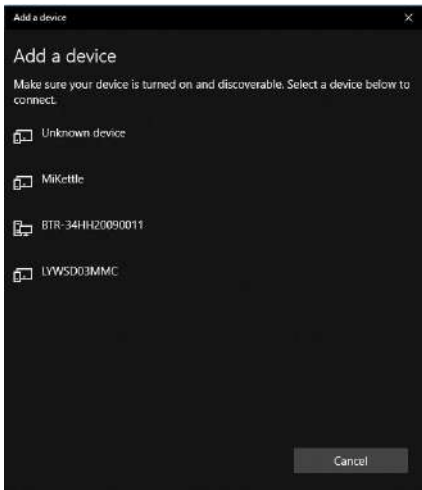
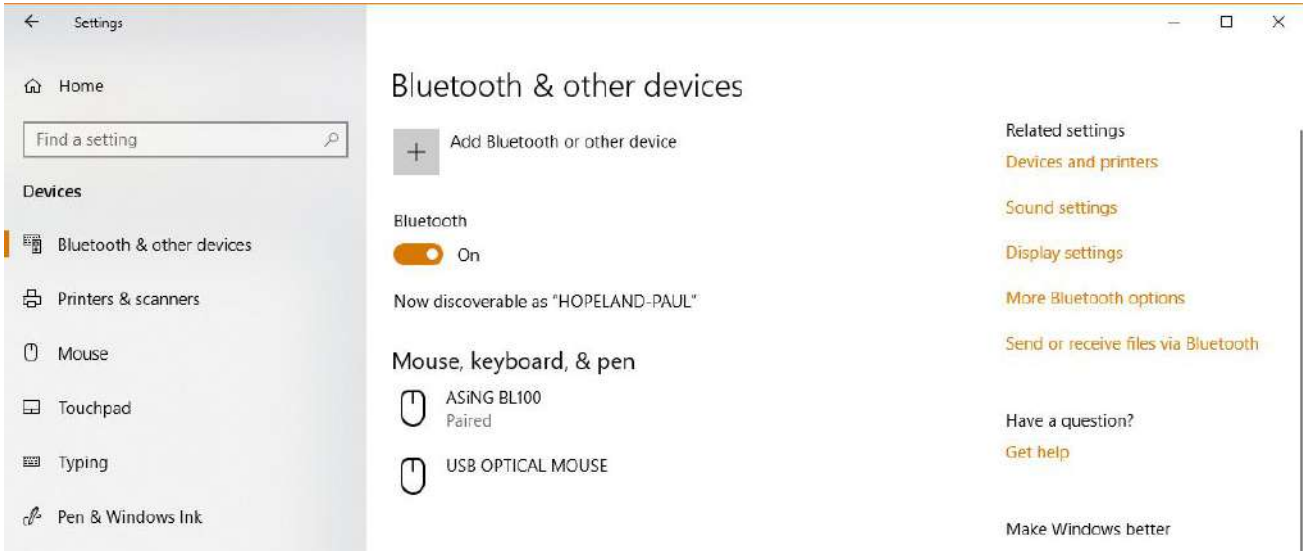

4.5 Mobile Network Settings

Reader has built-in 4G function and supports global 4G frequency band. Reader Android OS is used to set the relevant parameters of the mobile network.

1. According to the content in chapter 3.3.4, install the mobile phone SIM card when the reader is turned off
2. Connect the 2pcs 4G antennas provided with the reader to the 4G antenna interfaces of the reader



3. Set the mobile network related parameters through the Android system of the reader

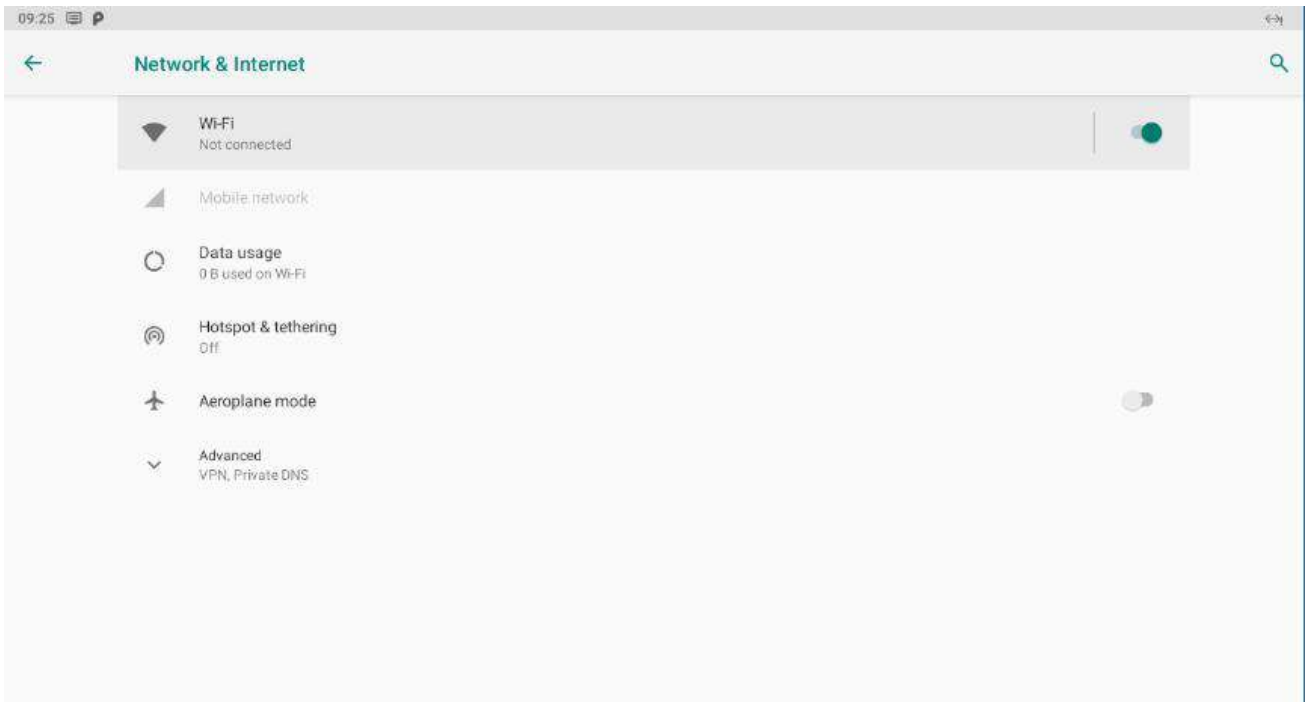

4.6 Run Android Demo

You can install Android demo in Shine series reader. Click the icon of Android demo to run

Android demo, choose TCP as the connection method, the parameters are the IP address and port number of the reader.

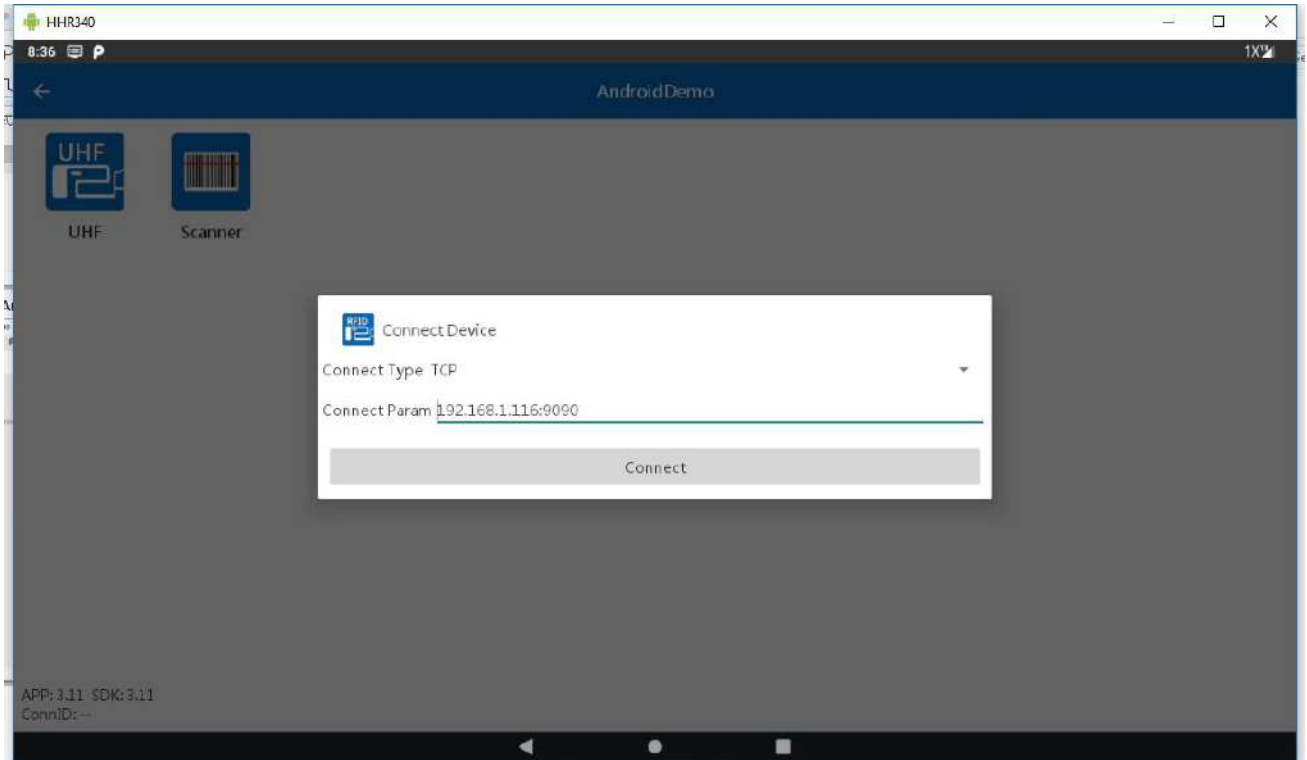
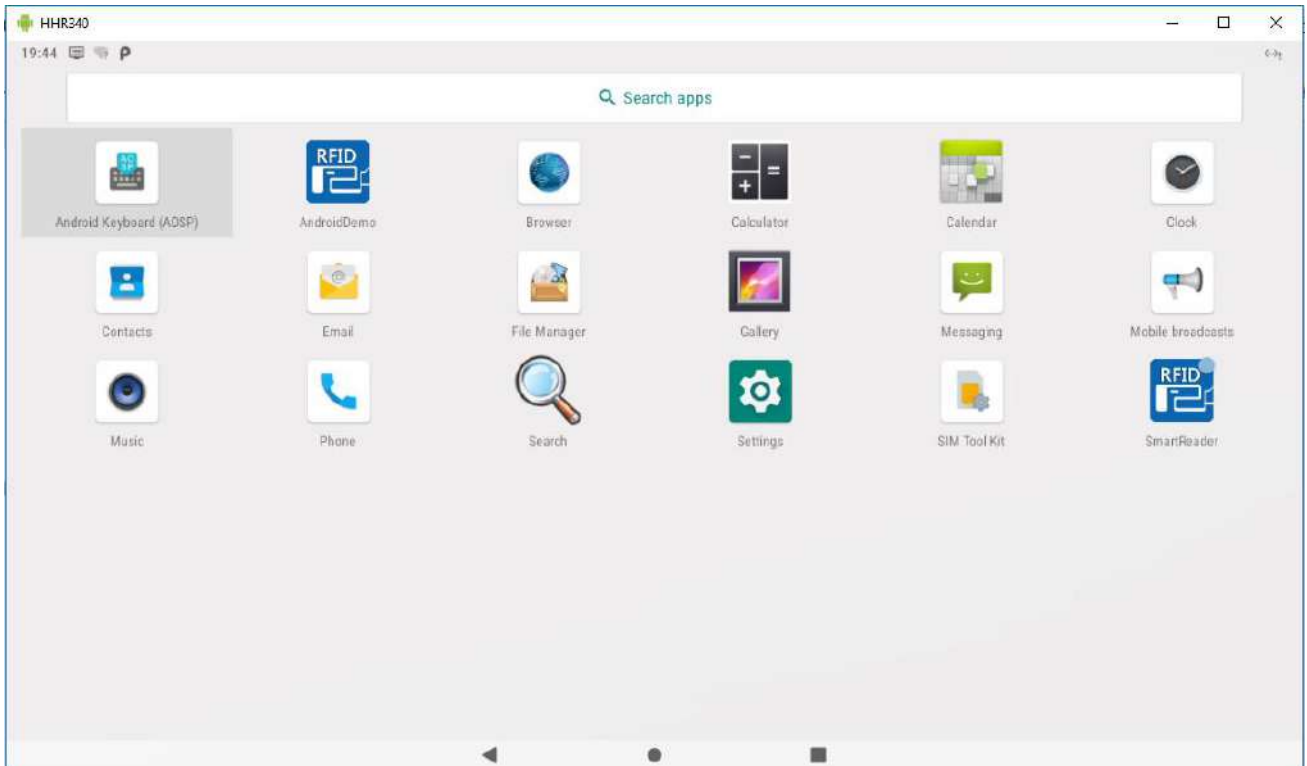



EPC	RSSI	Count
ABCDEDED123515D4885E580000	-48.8	30
E200001D46010045126014CE	-37.8	30
3456	-55.8	30
105023AA267566F246455443	-58.3	28
E200001D4601003612300D1A	-53.0	28
30361F861825D3AE1737517C	-56.4	30

Time:1841mS SP:93T/S Total:6

Inventory View Clear Save

5. Web page Operation Instructions

5.1 System Login

5.1.1 Login

It is recommended to use Google Chrome to log in. When logging in, please enter the URL of the reader in the address bar, such as: `http://192.168.1.116:8080/`. The login interface is shown in Figure 5.1.1. Enter the username and password, and click the "Login" button to log in. (The default administrator account is admin, and the password is admin)

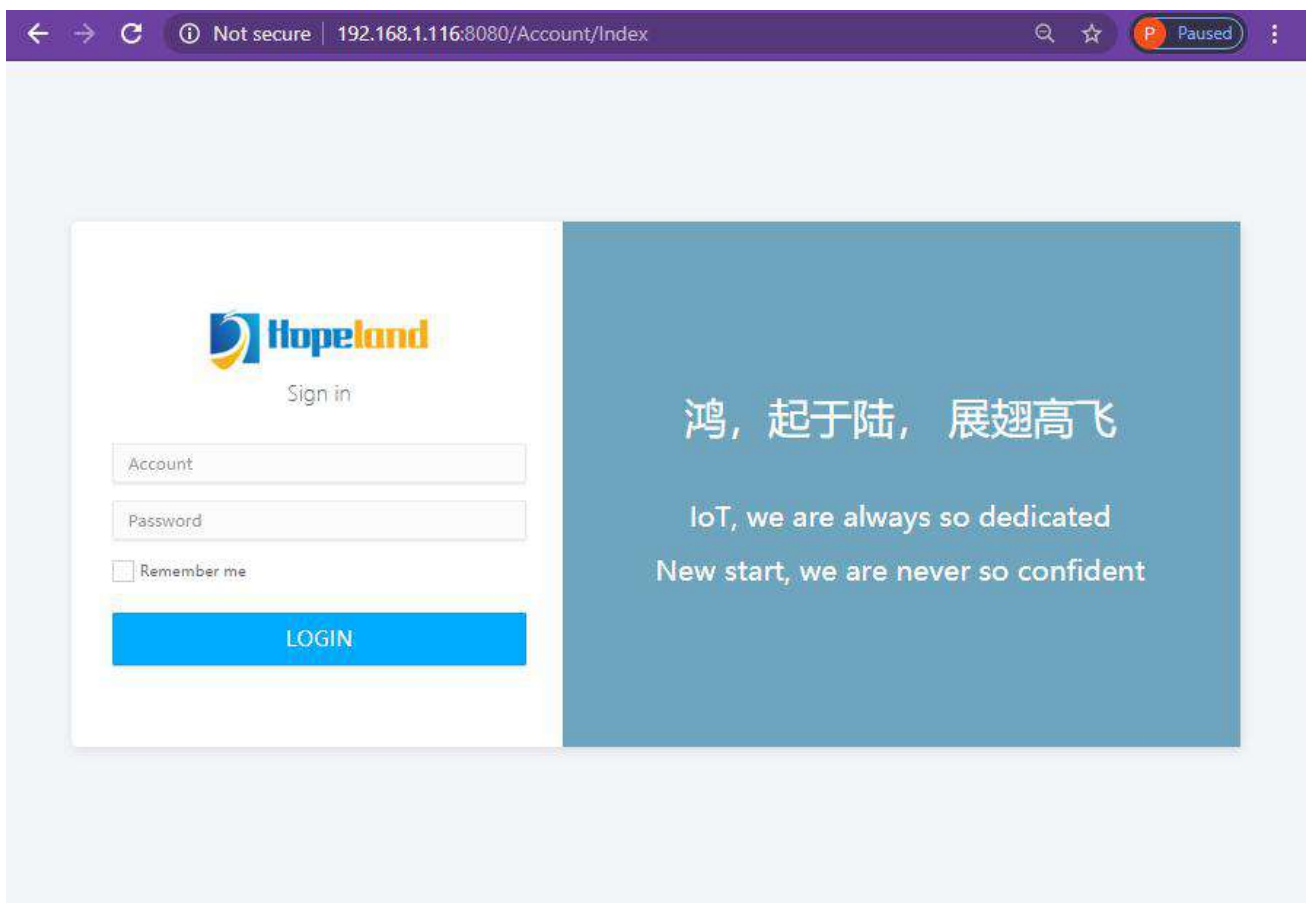

Figure 5.1.1

5.1.2 System Navigation

After a successful login, the system is shown in Figure 5.1.2. The left side is menu navigation, which has functions of RFID settings, reader settings, advanced setup, log management, etc., the right side is the current function page, and the default is the welcome page.

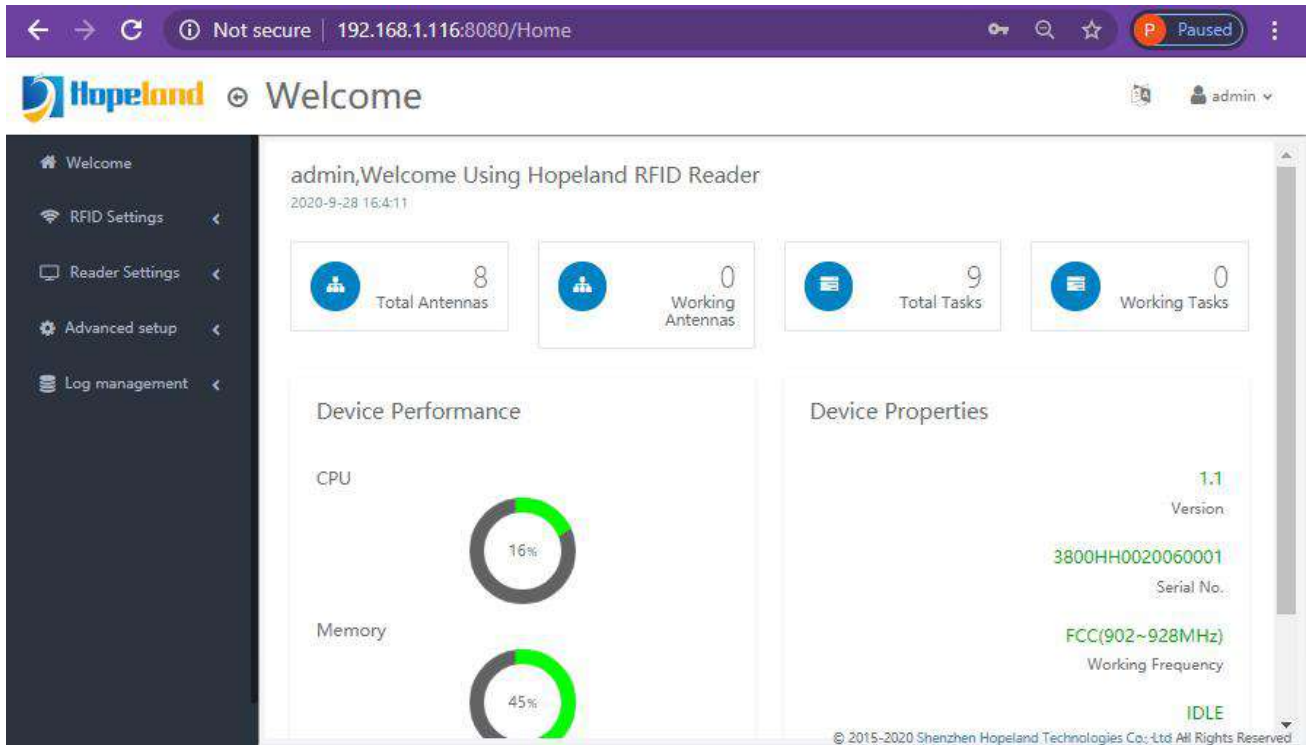

Figure 5.1.2

5.2 RFID Settings

The RFID setting menu includes antenna configuration, frequency configuration, baseband configuration and advanced baseband configuration.

5.2.1 Antenna Configuration

Click RFID Settings-->Antenna Power under the left navigation to enter the antenna configuration page, as shown in Figure 5.2.1.

On the antenna power page, you can check the antenna to be used and select the power for configuration. Antennas that are not checked will be disabled.

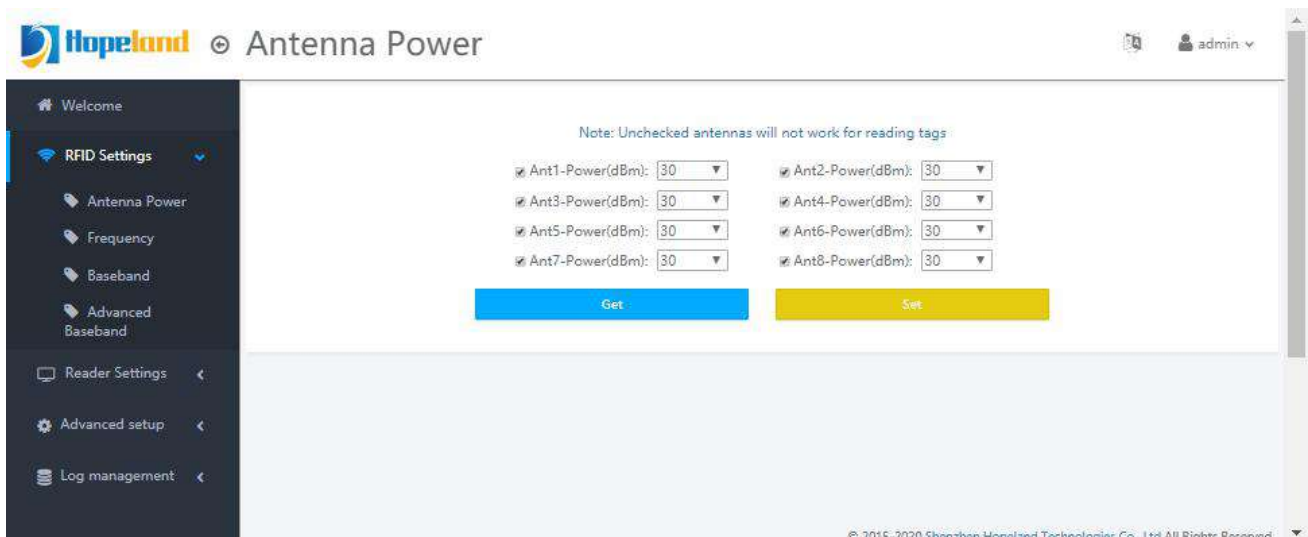

Figure 5.2.1

5.2.2 Frequency Configuration

Click RFID Settings-->Frequency under the left navigation to enter the frequency configuration page, as shown in Figure 5.2.2.

Frequency can set the working frequency band, frequency hopping mode and working frequency points of the device. When the Freq Hopping mode selects Auto, the frequency list cannot be selected. Setting a band not supported by the device will fail.

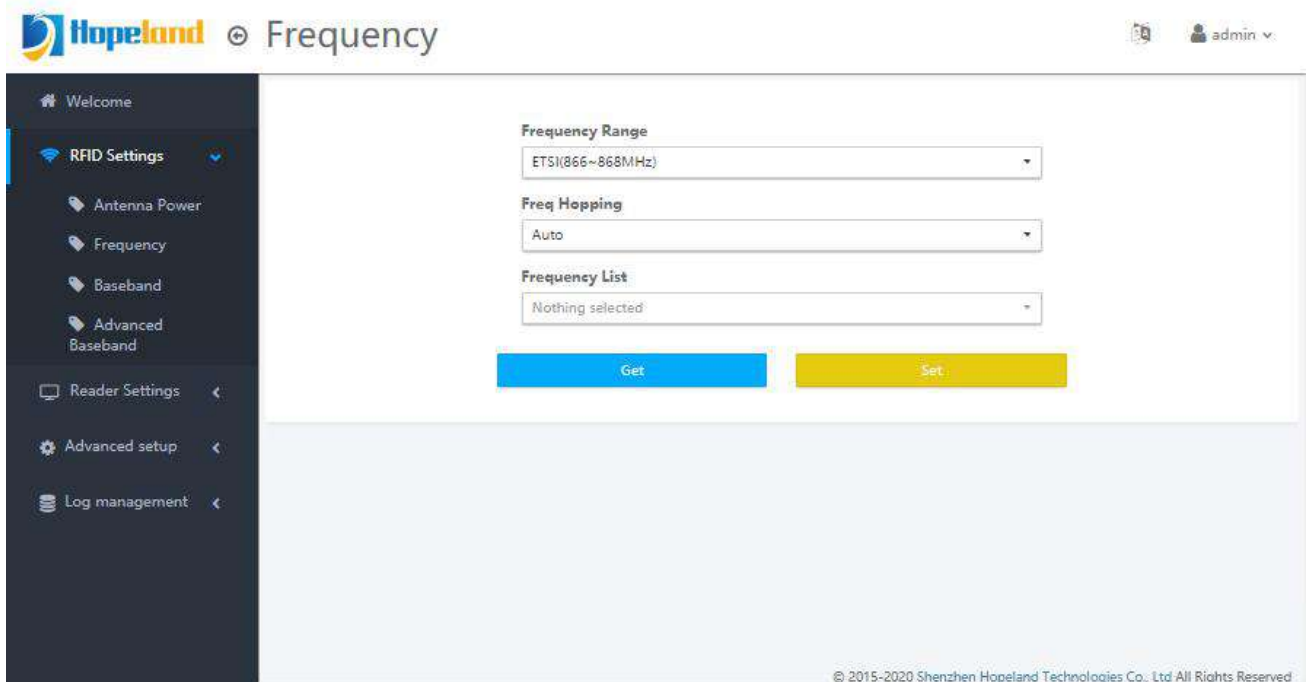

Figure 5.2.2

5.2.3 Baseband Configuration

Click RFID Settings-->Baseband under the left navigation to enter the baseband configuration page, which is shown in Figure 2.3.1.

The baseband configuration page allows you to configure the baseband rate, Q value, session, and inventory flags.

- ✧EPC Speed: Determine the encoding method and communication rate of the reader and tag.
- ✧Q value: determine the initial Q value of the anti-collision algorithm
- ✧Session: Determine the Session used in the inventory process
- ✧Inventory flag: Determine the inventory flag in the inventory process, where under the Flag A&B inventory flag mode, the device will automatically switch Flag A and Flag B.

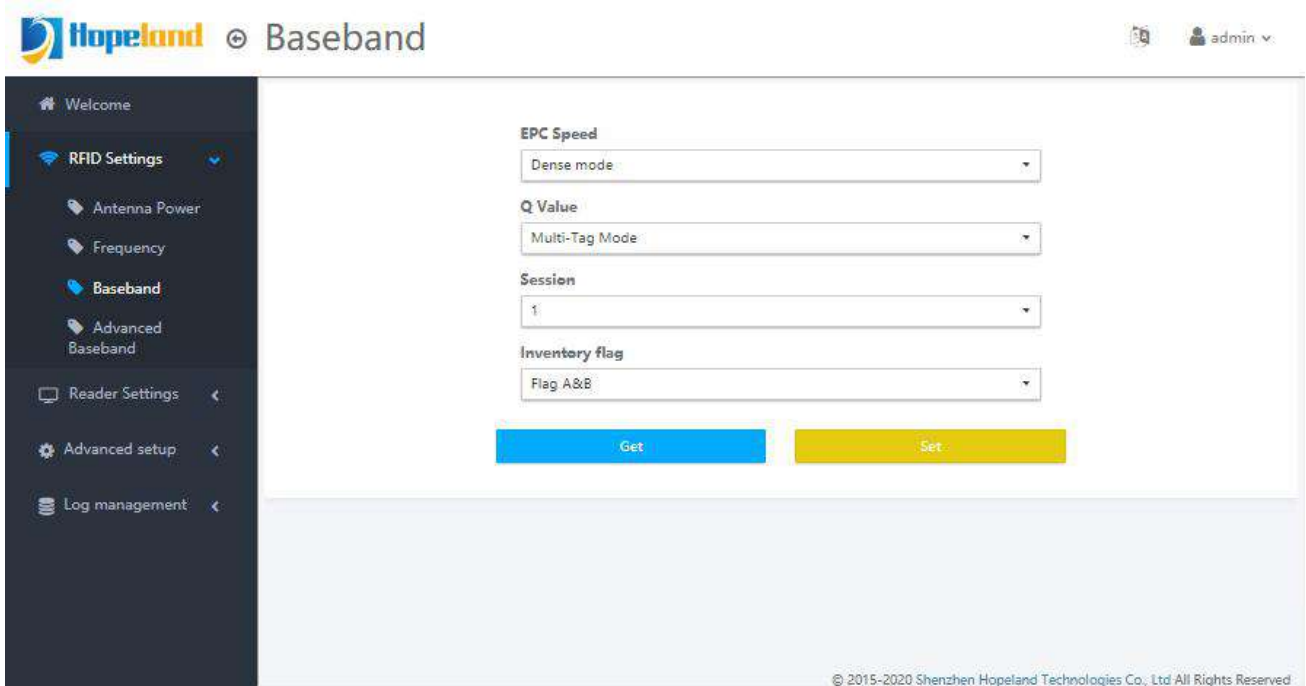

Figure 5.2.3

5.2.4 Advanced Baseband Settings

Click RFID Settings-->Advanced Baseband under the left navigation to enter the advanced baseband settings page, as shown in Figure 5.2.4.

In the Advanced Baseband Settings page, antenna switching mode, dynamic Q algorithm, and special tag inventory can be configured.

- ✧ TagFocus: Use TagFocus technology to read tags, and the tags need to support TagFocus technology
- ✧ FastID: FastID technology is used to read tags (TID can be read directly when reading EPC), the tags need to support FastID technology
- ✧ minQ: Minimum Q value of dynamic Q algorithm
- ✧ maxQ: Maximum Q value of dynamic Q algorithm
- ✧ tmult: Dynamic Q algorithm coefficient
- ✧ Antenna mode: The antenna switching mode can be configured to switch immediately without tag or use up the residence time
- ✧ Residence time: Set an antenna residence time, set to 0 for the default residence time.
- ✧ Waiting time: Set the waiting time between antenna switching.
- ✧ Retries: Number of retries without reading any tags, a reference option for antenna switching

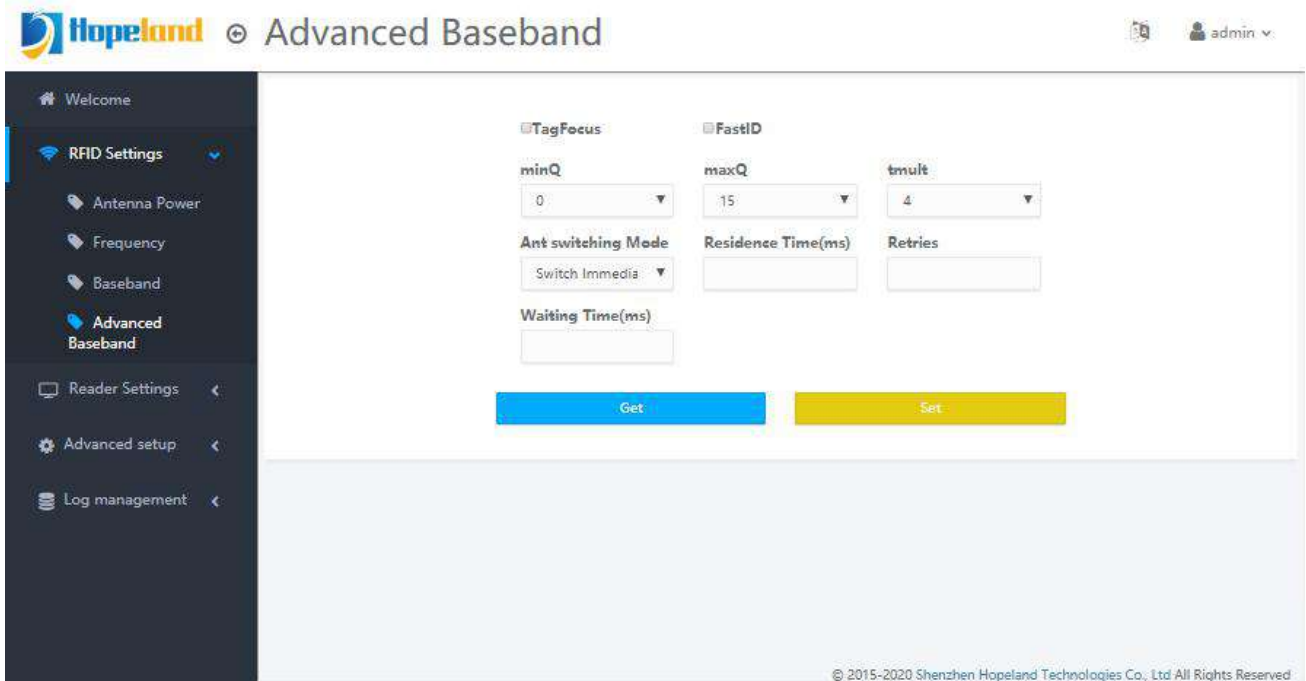

Figure 5.2.4

5.3 Reader Settings

The reader settings contains Ethernet configuration, wireless network configuration, RS485 configuration and advanced network parameters.

5.3.1 Ethernet Configuration

Click Reader Settings-->Ethernet under the left navigation to enter the Ethernet configuration page, which is shown in Figure 5.3.1.

The Ethernet Configuration page allows you to view the current Ethernet connection status and configure the network parameters and DHCP mode for Ethernet.

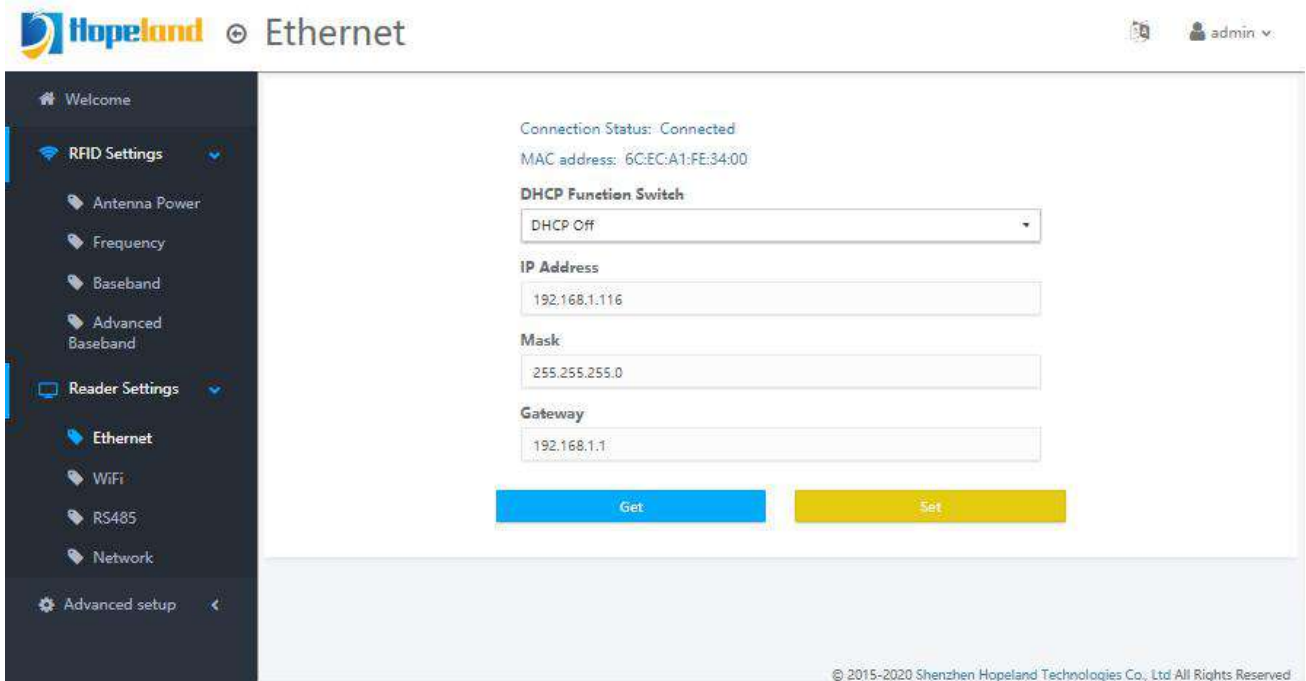

Figure 5.3.1

Note: The IP address here is the set value, not the actual value (the actual IP may be different after enabling DHCP)

Note: Ethernet settings need to restart reader to take effect

5.3.2 Wireless Network Configuration

Click Reader Settings-->WiFi under the left navigation to enter the wireless network configuration page, which is shown in Figure 5.3.2.

The wireless network configuration page can check the current wireless network connection status, and configure the wireless network switch, DHCP mode and wireless network parameters.

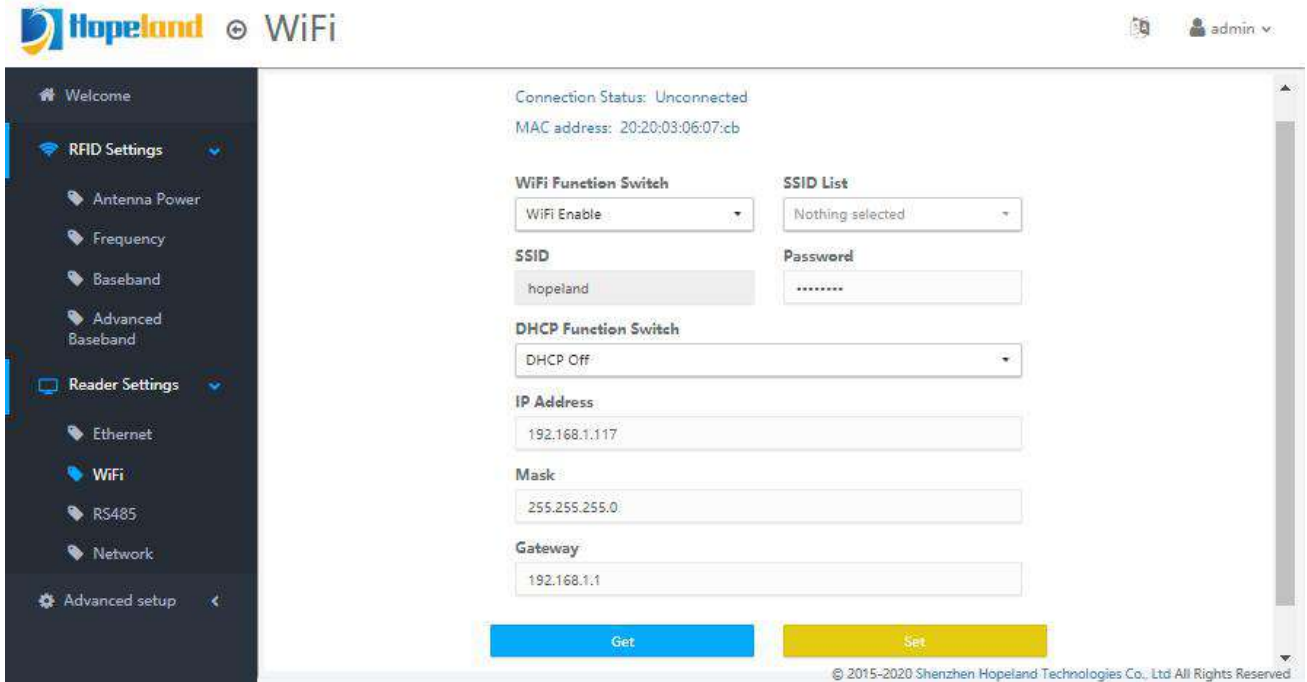

Figure 5.3.2

Note: The IP address here is the set value, not the actual value (the actual IP may be different after enabling DHCP)

5.3.3 RS485 Configuration

Click Reader Settings-->RS485 under the left navigation to enter the RS485 configuration page, which is shown in Figure 5.3.3.

The RS485 configuration page allows you to view and configure the baud rate and address of the RS485 communication.

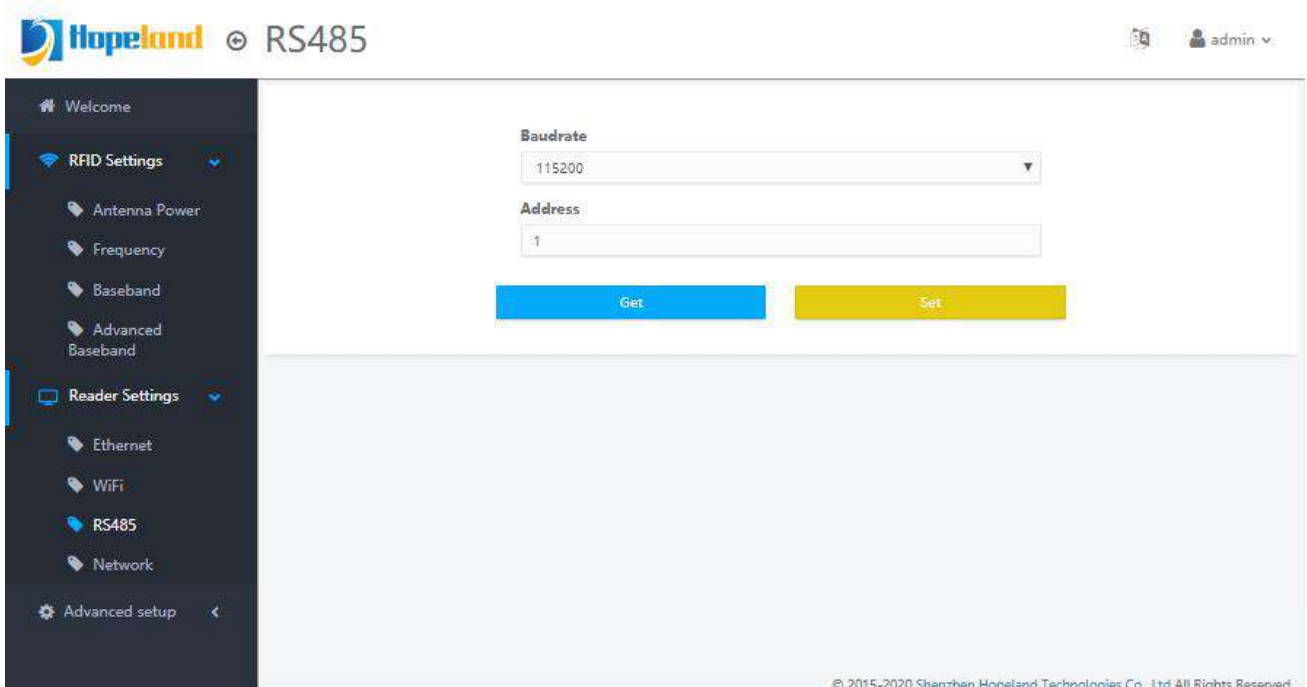

Figure 5.3.3

Note: RS485 settings need to be restart reader to take effect

5.3.4 Advanced Network Parameters

Click Reader Settings-->Network under the left navigation to enter the advanced network parameter setting page, which is shown in Figure 5.3.4.

The advanced network parameters page allows you to set the heartbeat packet and TCP client/service mode for communication. You need to check the box if you want to set a particular function.

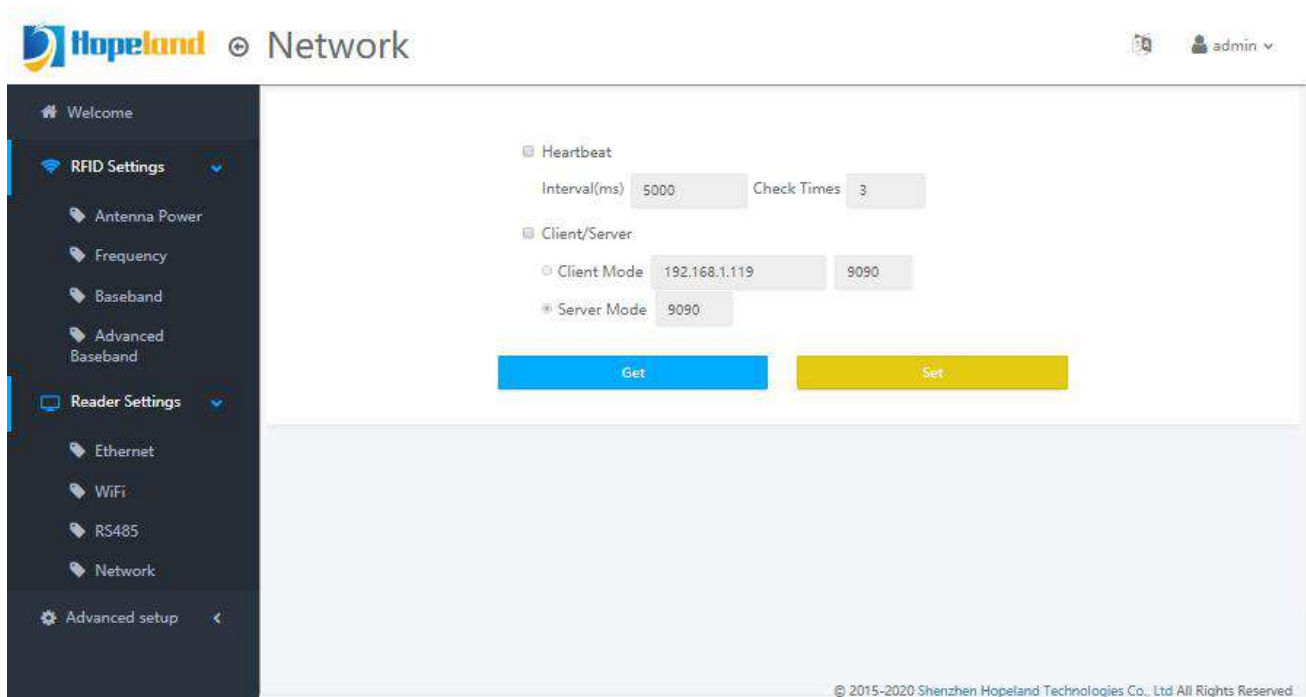

Figure 5.3.4

5.4 Advanced Setup

The advanced settings menu contains advanced settings, filter settings, task settings, and account editing.

5.4.1 Advanced Setup

Click Advanced Setup-->Advanced Setup under the left navigation to enter the advanced settings page, which is shown in Figure 5.4.1.

The Advanced Settings page allows you to set the reader time, reader buzzer, and customer code. If you need to set a certain function, you need to check it first.

The Advanced Settings page allows you to import and export reader parameters for batch configuration of readers for the same application.

The advanced settings page allows you to upgrade the embedded app and baseband.

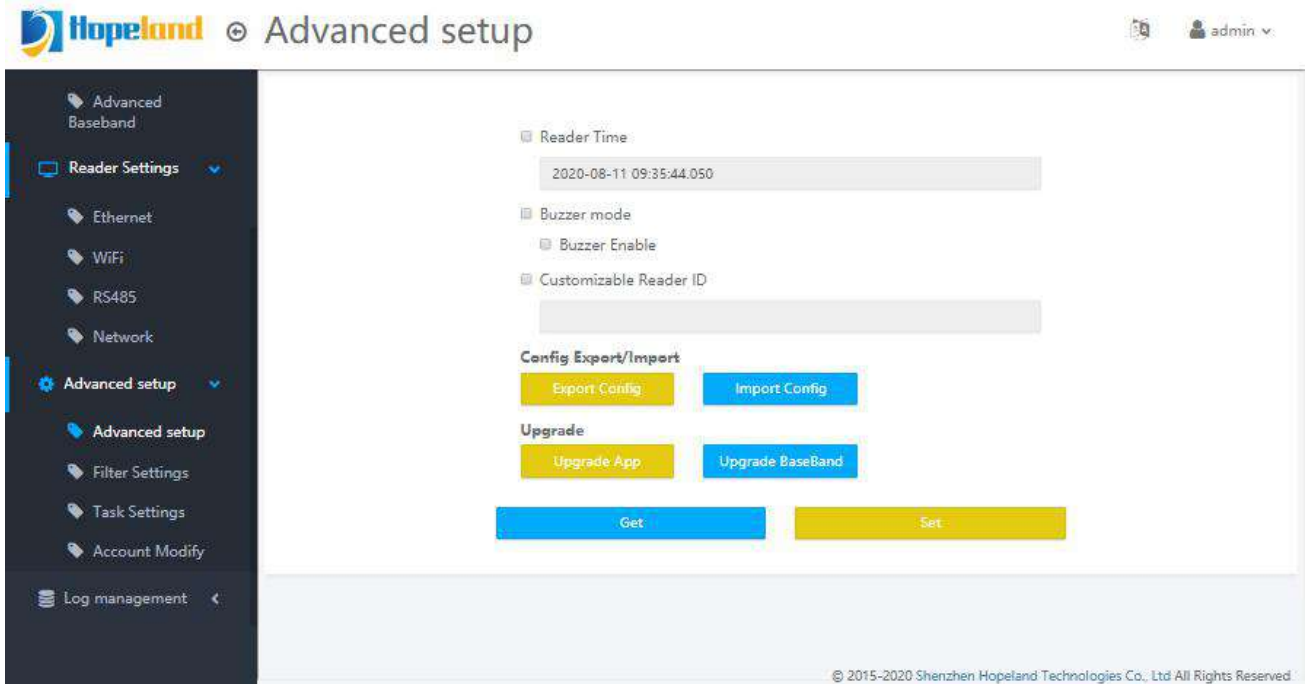

Figure 5.4.1

Note: The correct firmware must be used to upgrade, otherwise the device will not function properly.

5.4.2 Filter Settings

Click Advanced Settings-->Filter Settings under the left navigation to enter the filter settings page, which is shown in Figure 5.4.2.

Filter settings for tag RSSI threshold filtering, read time filtering and regular expression filtering for tag EPC/TID.

If you don't need to enable regular expression filtering, just clear the expression.

Example of a regular expression:

`^E280.*`

Meaning: reads only tags beginning with E280

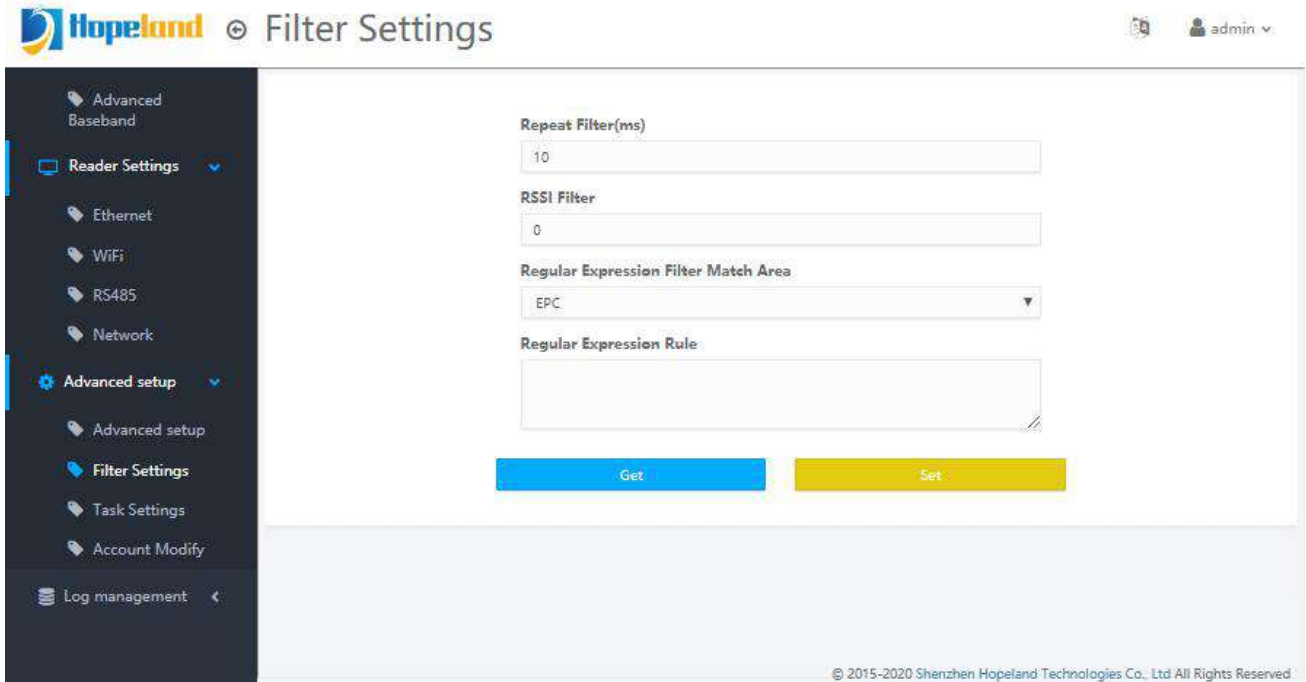

Figure 5.4.2

5.4.3 Task Settings

Click Advanced Settings-->Task Settings under the left navigation to enter the task settings page, which is shown in Figure 5.4.3.

The task settings interface allows you to view the task status and control the enable/disable of the task.

In the task setting interface, you can click the Set button to configure the specified task.

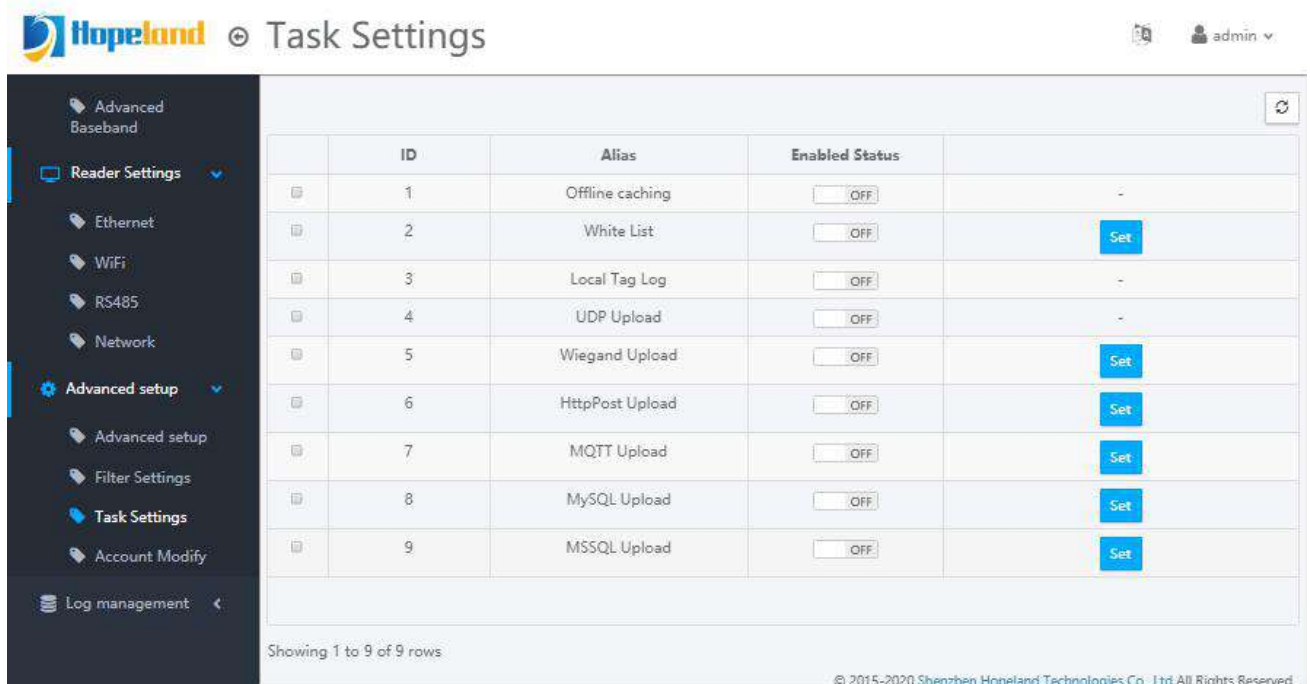

Figure 5.4.3

5.4.3.1 Offline Cache

The offline cache task is used to cache the read data into the database when the reader is disconnected during the tag reading process. After the host is reconnected, offline data for this period can be retrieved.

5.4.3.2 Whitelist

The whitelist task is used to process tag events related to the tags in the whitelist. It includes triggering the corresponding relay action after matching the whitelist tag, triggering the buzzer alarm after reading any tag, triggering the relay action after reading any tag, and triggering the buzzer and relay action simultaneously after reading any tag. Whitelist task configuration parameters are shown in Figure 5.4.3.2.1

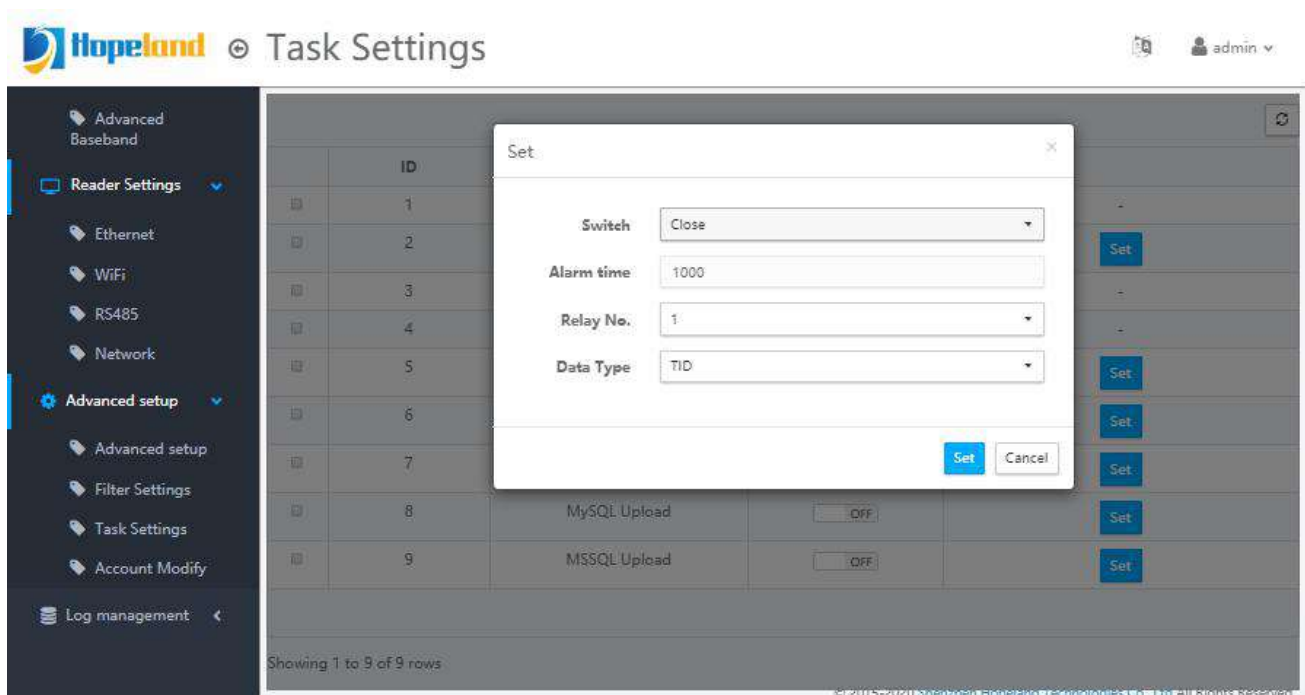

Figure 5.4.3.2.1

5.4.3.3 Local Tag Log

The local tag log is used to record the read tags into the tag log.

5.4.3.4 UDP Upload

The UDP upload task is used to send the read tags to the specified server in the format specified.

5.4.3.5 Wiegand Upload

Wiegand Upload is used to pass the read tags to the Wiegand controller in the format set via Wiegand communication. As shown in Figure 5.4.3.5.1.

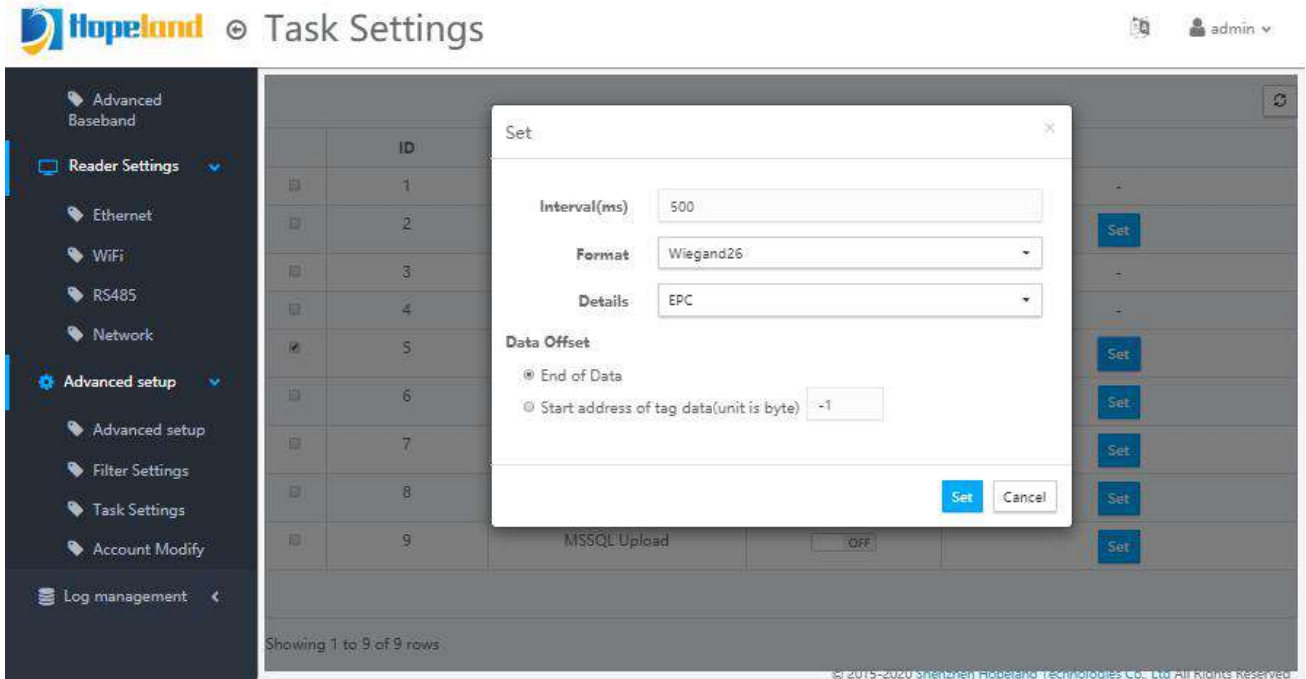

Figure 5.4.3.5.1

5.4.3.6 HttpPost Upload

The HttpPost upload task is to transmit the tag data in JSON format to the specified server URL.

Parameters such as tag data fields and upload interval can be configured through the common parameter of the configuration interface, as shown in Figure 5.4.3.6.1; server URL information can be configured through the specified parameter of the configuration interface, as shown in Figure 5.4.3.6.2

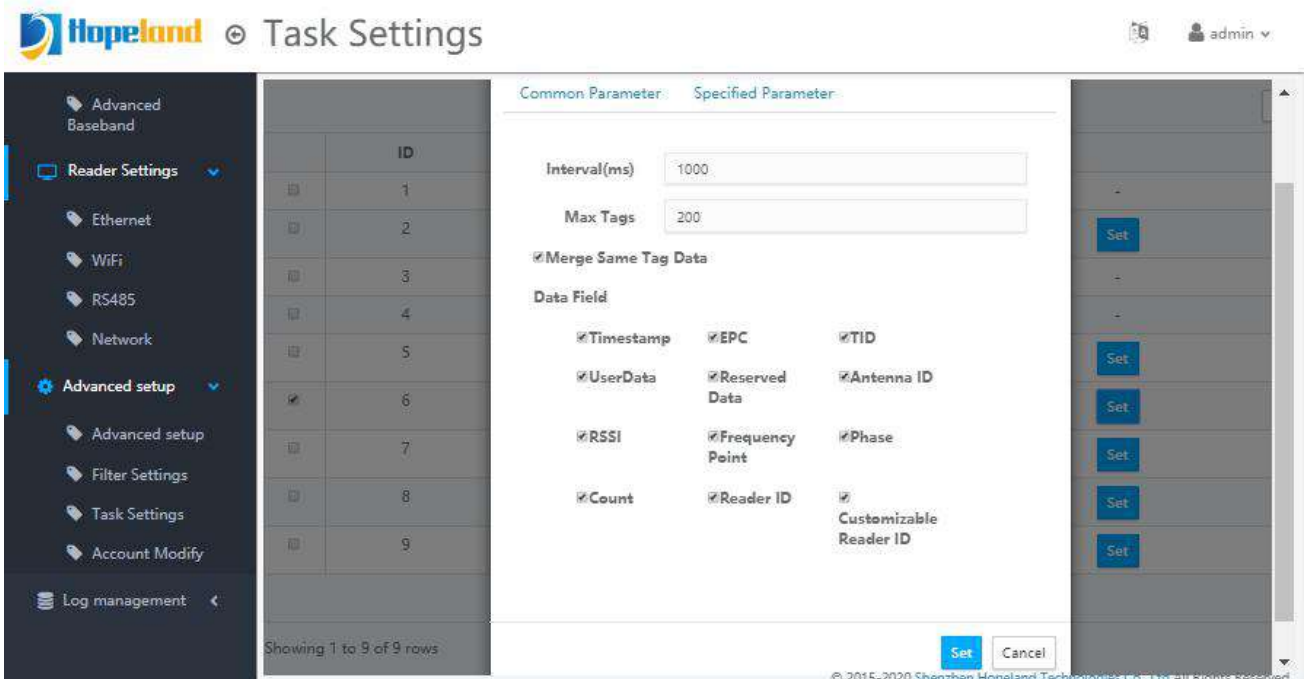

Figure 5.4.3.6.1

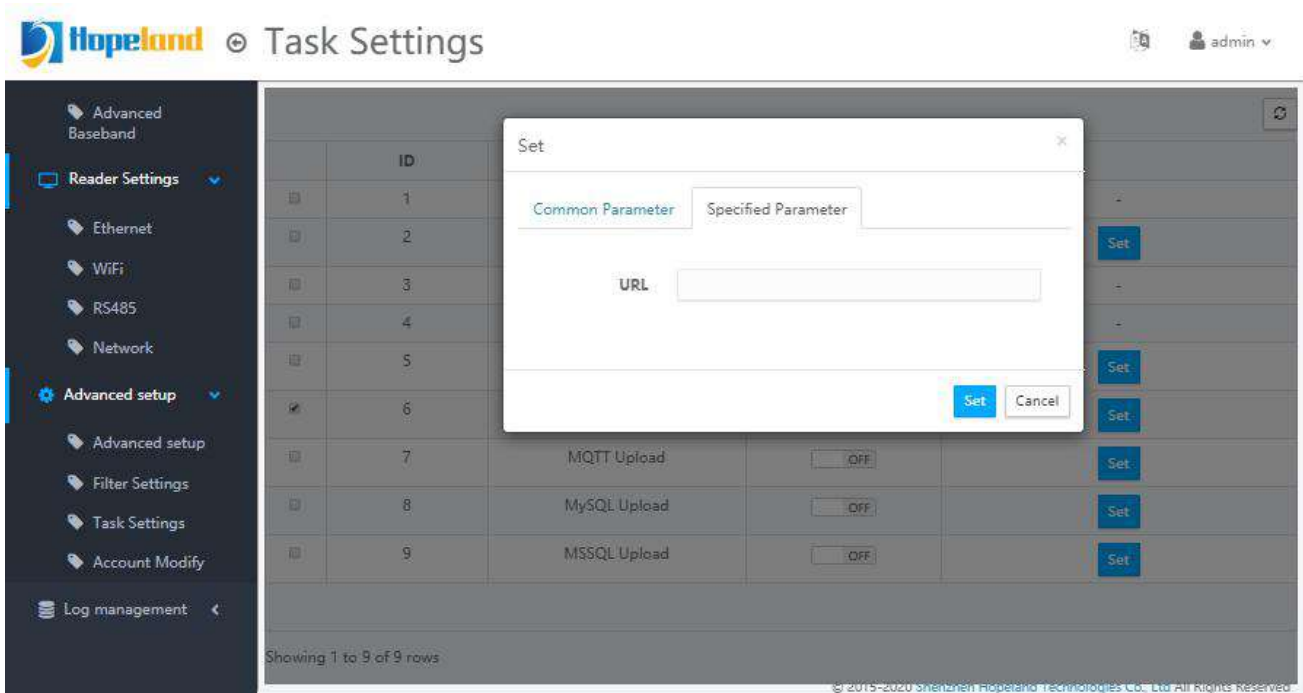

Figure 5.4.3.6.2

5.4.3.7 MQTT Upload

The MQTT upload task is to transmit the tag data to the specified MQTT server in JSON format.

Parameters such as tag data fields and upload interval can be configured through the common parameter of the configuration interface, as shown in Figure 5.4.3.7.1; server information can be configured through the specified parameter of the configuration interface, as shown in Figure 5.4.3.7.2.

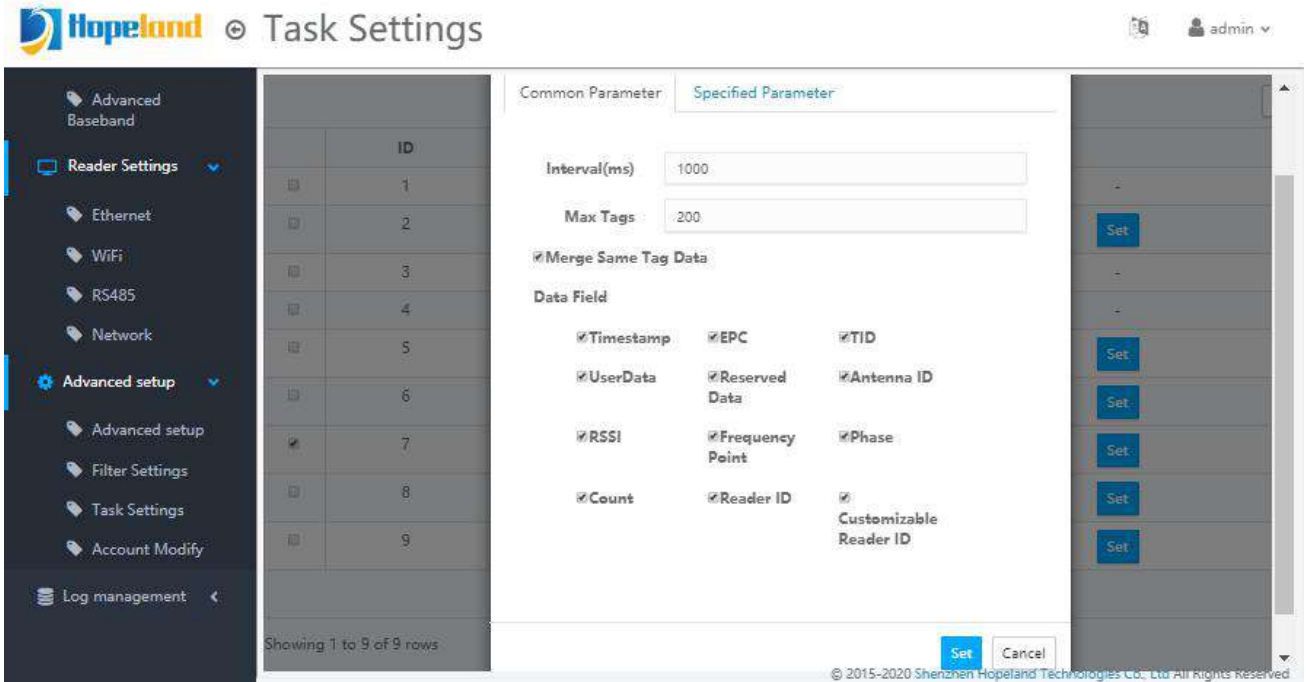

Figure 5.4.3.7.1

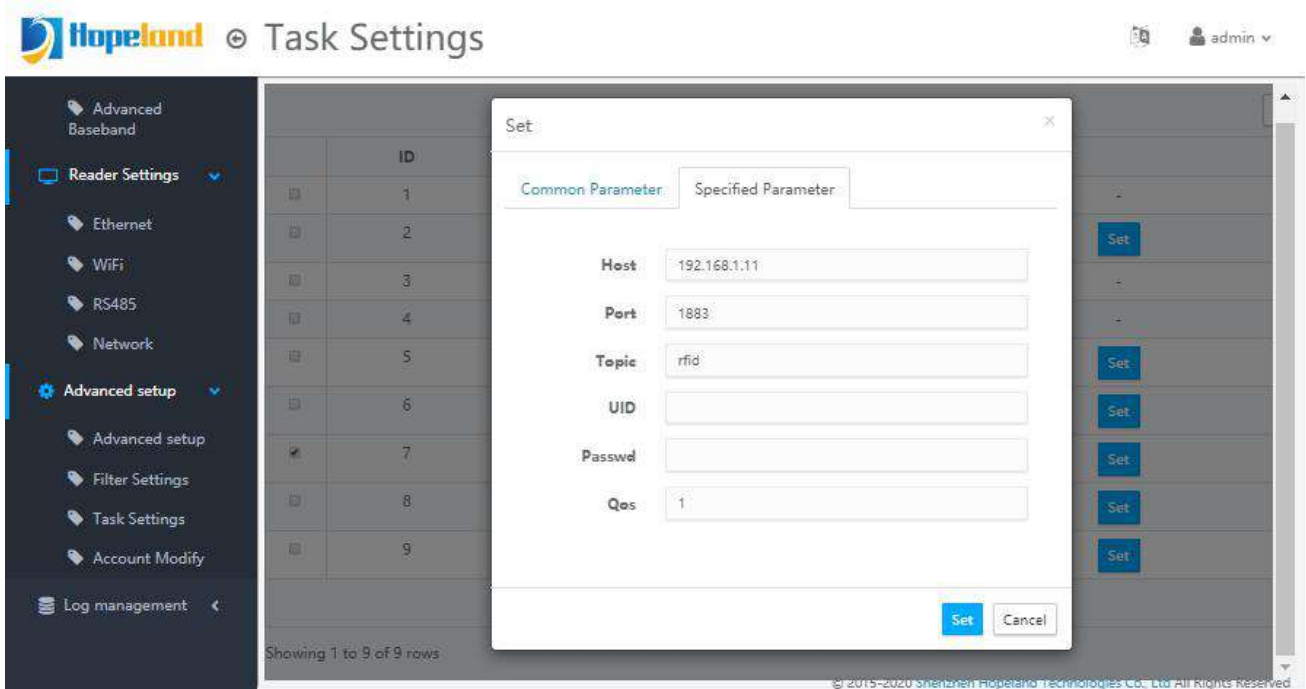

Figure 5.4.3.7.2

5.4.3.8 MySQL Upload

The MySQL upload task is to write tag data into the specified MySQL database. Parameters such as tag data fields and upload interval can be configured through the common parameter of the configuration interface, as shown in Figure 5.4.3.8.1; server information can be configured through the specified parameter of the configuration interface, as shown in Figure 5.4.3.8.2.

Create the same database name and table in the MySQL database, and create the table structure according to the sample SQL script. The order of the fields doesn't matter, as long as the data types of the fields are correct, as shown in Figure 5.4.3.8.3. After starting the reader to read tags, the reader can transmit the read tag data to the specified MySQL database, as shown in Figure 5.4.3.8.4.

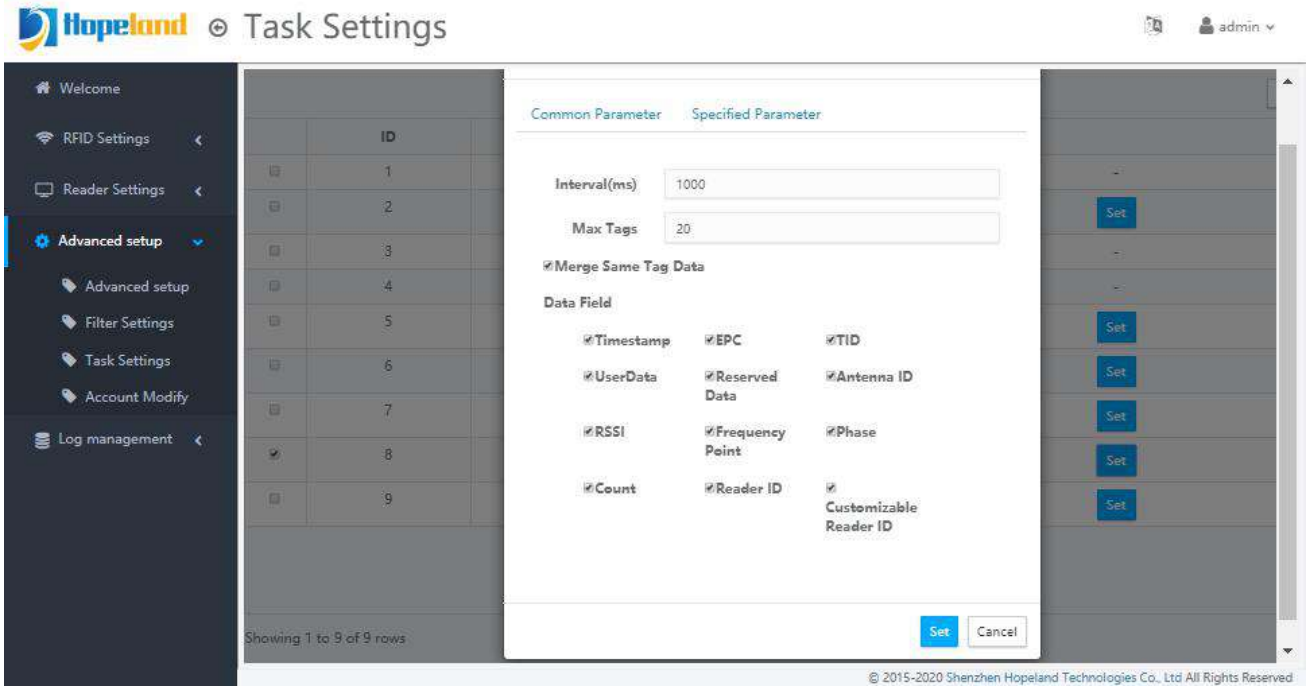

Figure 5.4.3.8.1

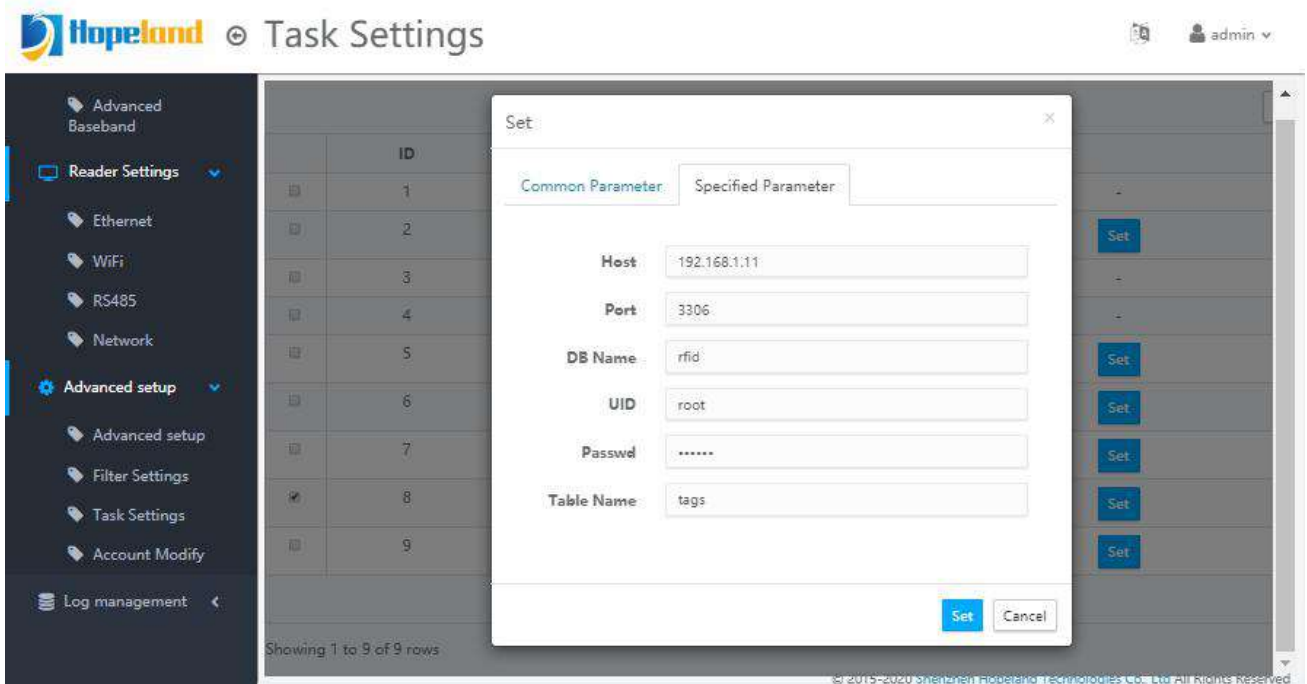

Figure 5.4.3.8.2

```

22 DROP TABLE IF EXISTS `tags`;
23 /*!40101 SET @saved_cs_client      = @@character_set_client */;
24 /*!50503 SET character_set_client = utf8mb4 */;
25 CREATE TABLE `tags` (
26   `id` int NOT NULL AUTO_INCREMENT,
27   `timestamp` datetime DEFAULT NULL,
28   `epc` varchar(64) DEFAULT NULL,
29   `tid` varchar(45) DEFAULT NULL,
30   `customcode` varchar(64) DEFAULT NULL,
31   `serialno` varchar(45) DEFAULT NULL,
32   `userdata` varchar(1024) DEFAULT NULL,
33   `reserved` varchar(64) DEFAULT NULL,
34   `ant` int DEFAULT NULL,
35   `rssi` int DEFAULT NULL,
36   `count` int DEFAULT NULL,
37   `freq` int DEFAULT NULL,
38   `phase` int DEFAULT NULL,
39   PRIMARY KEY (`id`)
40 ) ENGINE=InnoDB AUTO_INCREMENT=377 DEFAULT CHARSET=utf8;
    
```

Figure 5.4.3.8.3

The screenshot shows the MySQL Workbench interface. The query editor contains the SQL script from Figure 5.4.3.8.3. The result grid displays 11 rows of data with columns: id, timestamp, epc, tid, customcode, serialno, and userdata. The output pane shows the execution results of the queries.

id	timestamp	epc	tid	customcode	serialno	userdata
1	2020-08-06 15:06:57	E2000015110D00382040488C	E20034120134F80003FD958C	hopeland	3800HH0320070001	NULL
2	2020-08-06 15:06:57	00779A8441DDA811702A989	E28011052000780368830975	hopeland	3800HH0320070001	NULL
3	2020-08-06 15:06:57	E2806890000050033757696D	E2806890200050033757696D	hopeland	3800HH0320070001	NULL
4	2020-08-06 15:06:57	E2806890000050033757696E	E2806890200050033757696E	hopeland	3800HH0320070001	NULL
5	2020-08-06 15:06:57	E28068900000500337576970	E28068902000500337576970	hopeland	3800HH0320070001	NULL
6	2020-08-06 15:06:57	20207140001	E2806890200040033757696F	hopeland	3800HH0320070001	NULL
7	2020-08-06 15:06:57	E2806890000050033757696E	E2806890200050033757696E	hopeland	3800HH0320070001	NULL
8	2020-08-06 15:06:57	E2806890000040033757696C	E2806890200040033757696C	hopeland	3800HH0320070001	NULL
9	2020-08-06 15:06:57	2020999A	E28011052000500C58E302A2	hopeland	3800HH0320070001	NULL
10	2020-08-06 15:06:57	9C3C4F5520170902	E28011052000724199220948	hopeland	3800HH0320070001	NULL
11	2020-08-06 15:06:57	E2000015110D00462040457A	E20034120133F80003FD957A	hopeland	3800HH0320070001	NULL

Figure 5.4.3.8.4

5.4.3.9 MSSQL Upload

The MSSQL upload task is to write tag data into the specified MSSQL database.

Parameters such as tag data fields and upload interval can be configured through the common parameter of the configuration interface, as shown in Figure 5.4.3.9.1; server information can be configured through the specified parameter of the configuration interface, as shown in Figure 5.4.3.9.2.

Create the same database name and table in the Microsoft SQL Server database, and create the table structure according to the sample SQL script. The order of the fields doesn't matter, as long as the data types of the fields are correct, as shown in Figure 5.4.3.9.3. After starting

the reader to read tags, the reader can transmit the read tag data to the specified MS SQL database, as shown in Figure 5.4.3.9.4.

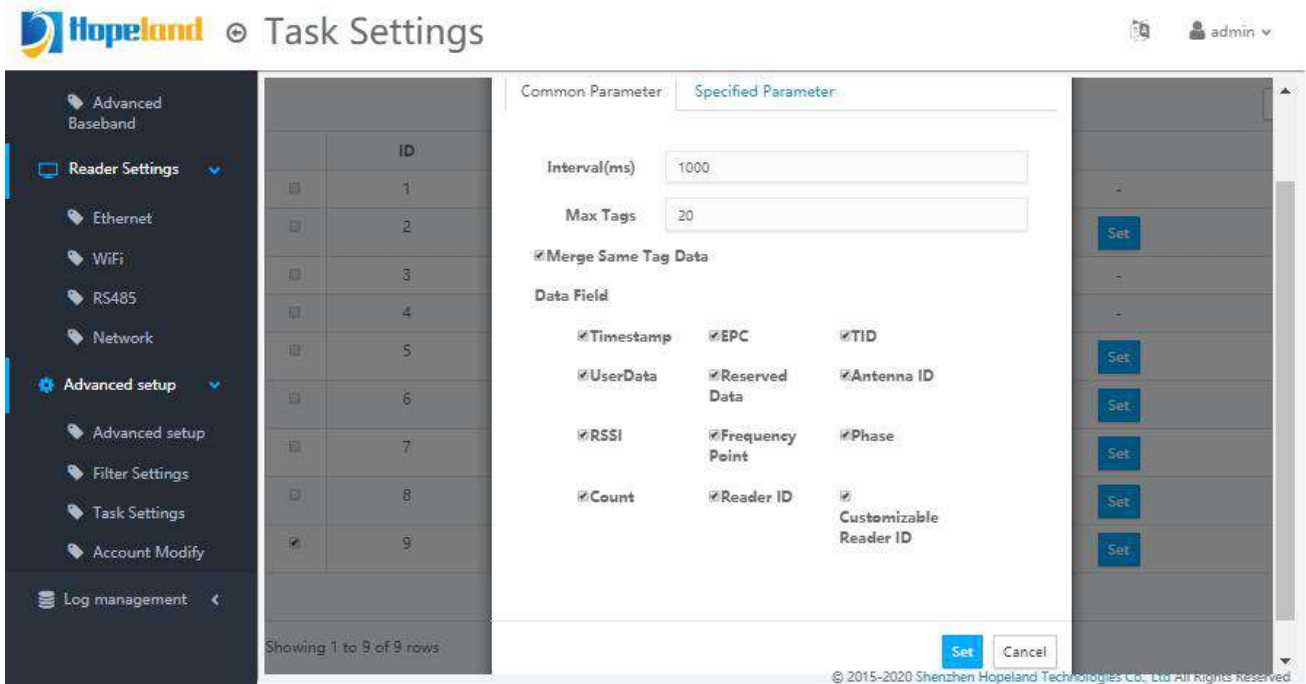

Figure 5.4.3.9.1

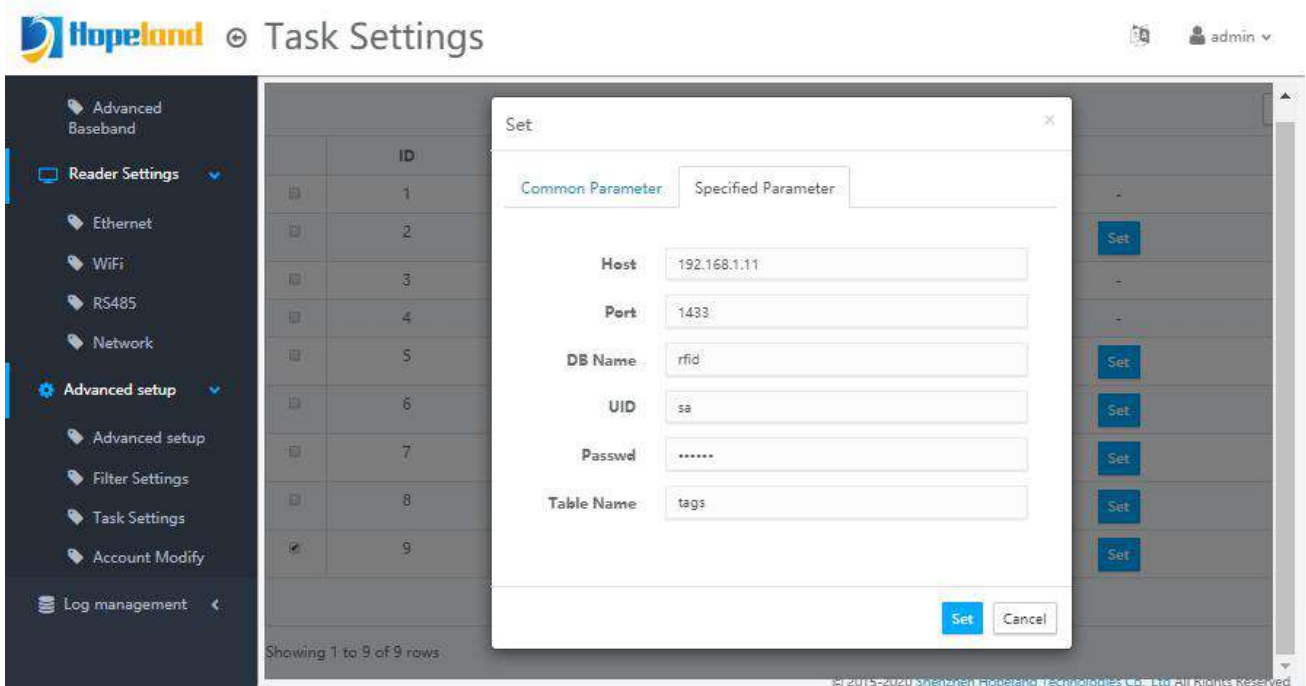

Figure 5.4.3.9.2

```

1  USE [rfid]
2  GO
3
4  /***** Object: Table [dbo].[tags]    Script Date: 2020/7/27 15:03:43 *****/
5  SET ANSI_NULLS ON
6  GO
7
8  SET QUOTED_IDENTIFIER ON
9  GO
10
11  CREATE TABLE [dbo].[tags] (
12      [id] [int] IDENTITY(1,1) NOT NULL,
13      [epc] [nvarchar](50) NULL,
14      [tid] [nvarchar](50) NULL,
15      [customcode] [nvarchar](50) NULL,
16      [serialno] [nvarchar](50) NULL,
17      [userdata] [text] NULL,
18      [reserved] [nvarchar](50) NULL,
19      [ant] [nchar](10) NULL,
20      [count] [int] NULL,
21      [rssi] [int] NULL,
22      [freq] [int] NULL,
23      [phase] [int] NULL,
24      [timestamp] [datetime] NULL,
25      CONSTRAINT [PK_tags] PRIMARY KEY CLUSTERED
26  (
27      [id] ASC
28  ) WITH (PAD_INDEX = OFF, STATISTICS_NORECOMPUTE = OFF, IGNORE_DUP_KEY = OFF,
29      ALLOW_ROW_LOCKS = ON, ALLOW_PAGE_LOCKS = ON) ON [PRIMARY]
30  ) ON [PRIMARY] TEXTIMAGE_ON [PRIMARY]
31  GO
    
```

Figure 5.4.3.9.3

The screenshot displays the SQL Server Enterprise Manager interface. On the left, the Object Explorer shows the server instance '192.168.1.75 (SQL Server 12)' with a database named 'rfid' containing a table 'dbo.tags'. The main window shows a query window with the following SQL script:

```

/***** Script for SelectTopNRows command from SSMS *****/
SELECT TOP 1000 [id]
, [epc]
, [tid]
, [customcode]
, [serialno]
, [userdata]
, [reserved]
, [ant]
, [count]
, [rssi]
, [freq]
, [phase]
, [timestamp]
FROM [rfid].[dbo].[tags]

truncate table rfid.dbo.tags
    
```

The Results pane shows the following data:

	id	epc	tid	customcode	serialno	userdata	reserv
1	1	E28068900000500337576970	NULL	hopeland	3800HH0320070001	NULL	NULL
2	2	00779A84441DDA811702A589	NULL	hopeland	3800HH0320070001	NULL	NULL
3	3	E2000015110D00462040457A	NULL	hopeland	3800HH0320070001	NULL	NULL
4	4	E2806890000040033757696C	NULL	hopeland	3800HH0320070001	NULL	NULL
5	5	2020999A	NULL	hopeland	3800HH0320070001	NULL	NULL
6	6	E2806890000050033757696D	NULL	hopeland	3800HH0320070001	NULL	NULL
7	7	E2000015110D00582040458C	NULL	hopeland	3800HH0320070001	NULL	NULL
8	8	9C3C4F5520170902	NULL	hopeland	3800HH0320070001	NULL	NULL
9	9	202007140001	NULL	hopeland	3800HH0320070001	NULL	NULL

Figure 5.4.3.9.4

5.4.4 Account Modify

Click Advanced Setup-->Account Modify under the left navigation to enter the account modify page, as shown in Figure 5.4.4.1. Enter the old password and the new password, and click the "Submit" button to modify the password.

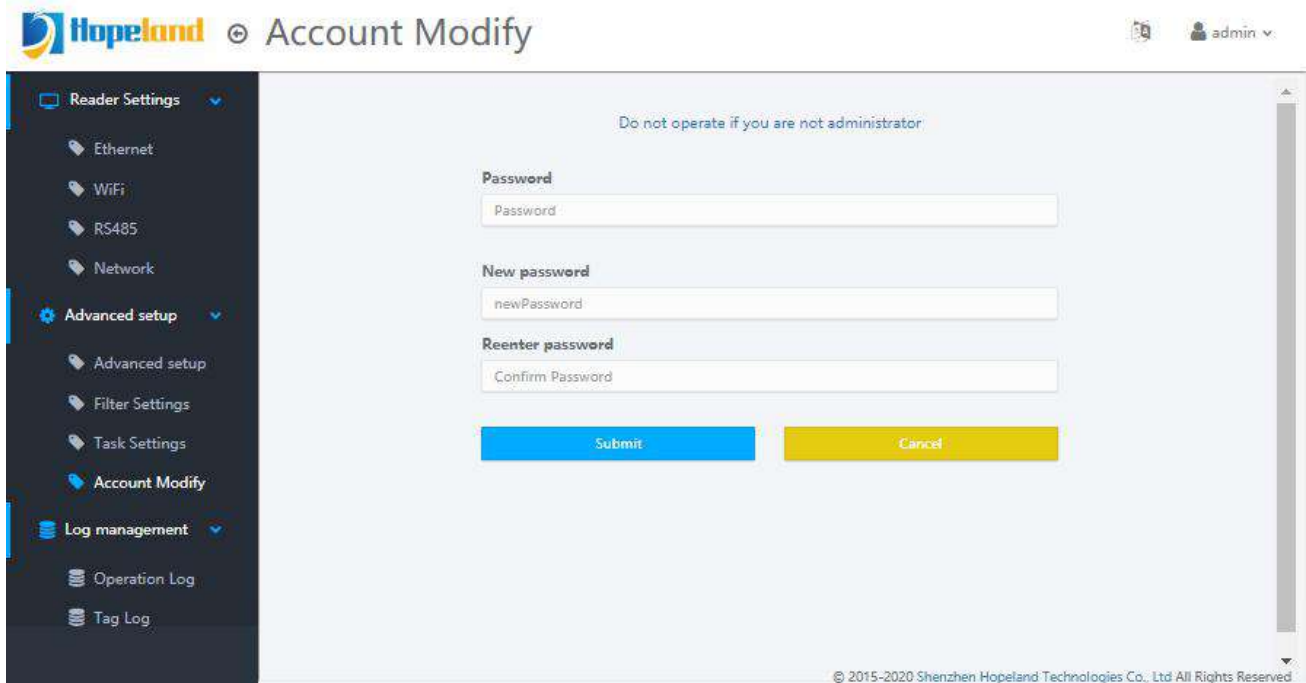

Figure 5.4.4.1

5.5 Log Management

The log management menu contains operation log and tag log.

5.5.1 Operation Log

Click Log Management-->Operation Log under the left navigation to enter the operation log page, which is shown in Figure 5.5.1.1.

The operation log records the logs generated during the running of the program, including internal logs, link logs, upload logs, web logs, radio frequency logs, link original messages, and radio frequency original messages. Can be selected via the toolbar.

The operation log includes the occurrence time, log type, log information and log data.

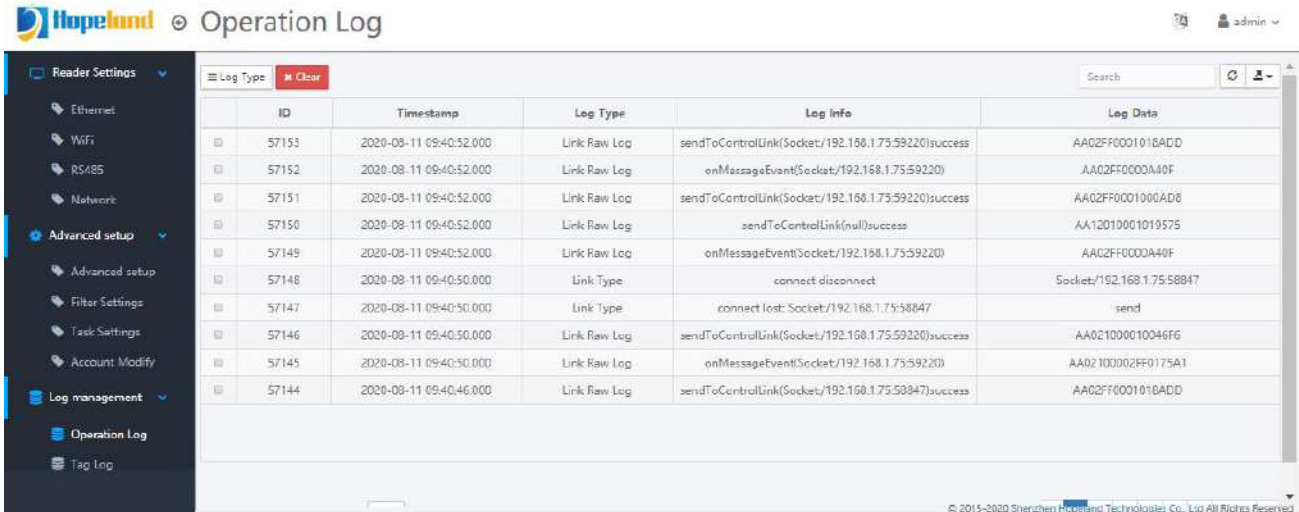

Figure 5.5.1.1

5.5.2 Tag Log

Click Log Management-->Tag Log under the left navigation to enter the tag log page, which is shown in Figure 5.5.2.1.

The tag log is the tag data recorded by the local tag log task.

The tag log includes timestamp, antenna, EPC, TID, user area, reserved area, reading times, RSSI, frequency, phase, etc.

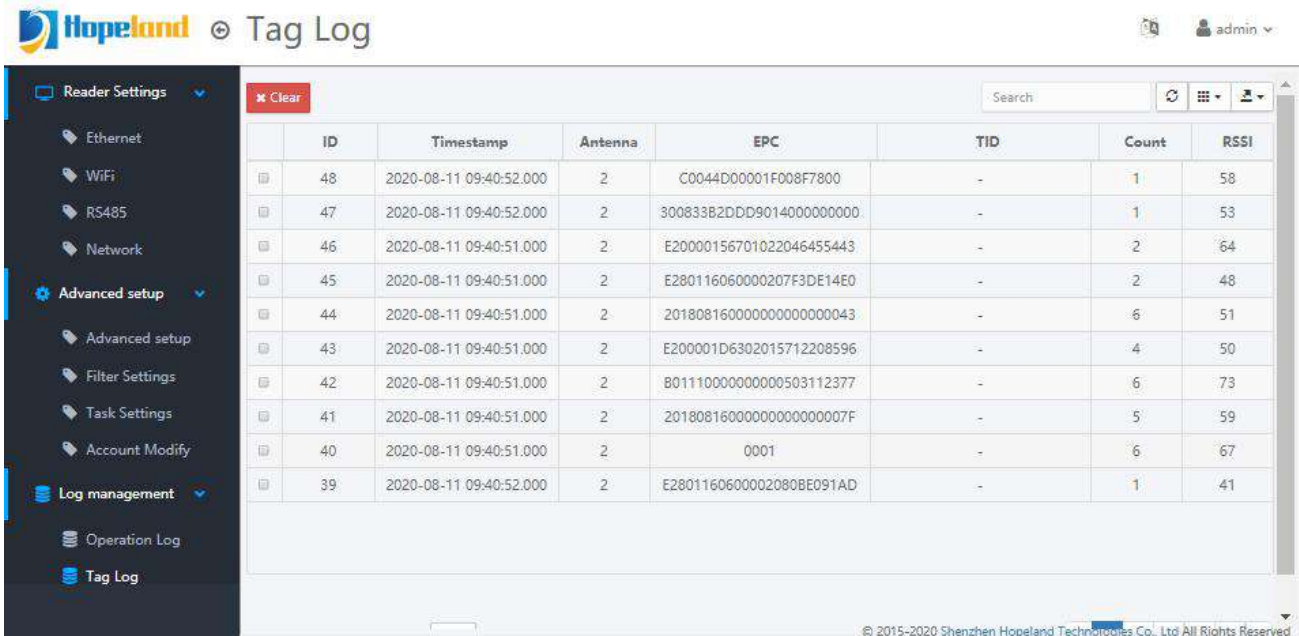

Figure 5.5.2.1

Appendix A Tag Field Correspondence Table

The JSON data and the corresponding fields of the database follow Table A.1.

Tag Data	Field	Description
Timestamp	timestamp	DateTime format: yyyy-MM-dd HH:mm:ss.SSS
EPC data	epc	String format, minimum length 24 characters
TID data	tid	String format, minimum length 24 characters
User data	userdata	String format, the minimum length is determined according to the size of the user area
Reserved data	reserved	String format, minimum length 16 characters
Antenna No.	ant	Int format
RSSI	rssi	Int format
Frequency	freq	Int format
Phase	phase	Int format
Read times	count	Int format
Serial number	serialno	String format, the minimum length is 16 characters; the serial number is the factory number of the device and cannot be modified
Customer code	customcode	String format, minimum length 20 characters; customer code is a code that can be set

Appendix A.1

6. Common Failures

6.1 Daily Maintenance

Daily maintenance of Shine 340/380 reader during use:

- ✧ Check whether the RF connector is tightened
- ✧ Check whether the screws fixing the reader and antenna are loose
- ✧ Check whether the outer shielding layer is disconnected at the RF cable connector
- ✧ Check whether the power cord of the reader is connected firmly

6.2 Common Failure Analysis And Solution

✧ **Power supply system failure:**

Check whether the power supply of the power adapter is normal and whether the AC power supply voltage is between 100V and 240V

✧ **After power on, the panel indicator does not light up:**

Confirm whether the communication is normal, if not, please contact after-sales service.

✧ **The serial port cannot be connected:**

The serial port cable is not connected or not firmly connected

Whether the serial port connection baud rate of the reader is correct

Is the selected COM port correct?

✧ **The network port cannot be connected:**

The default IP address of the Shine 340/380 reader is set at the factory: 192.168.1.116. Make sure that the IP address of the PC and the IP address of the reader are in the same network segment, such as "192.168.1.XXX". Connect with the reader, if you forget the IP address of the reader, you can reset the IP address of the reader through the serial port connection or pressing reset button for 10 seconds.

✧ **The reader cannot read tags**

■ Check if the antenna number is set correctly

■ Check if the tag is damaged

■ Check whether the tag placement position is within the effective reading and writing range of the reader

■ Check whether there is electromagnetic interference between readers or other devices

■ For problems that users cannot solve by themselves, please contact after-sales service.

7. Packaging Accessories And Storage

7.1 Package

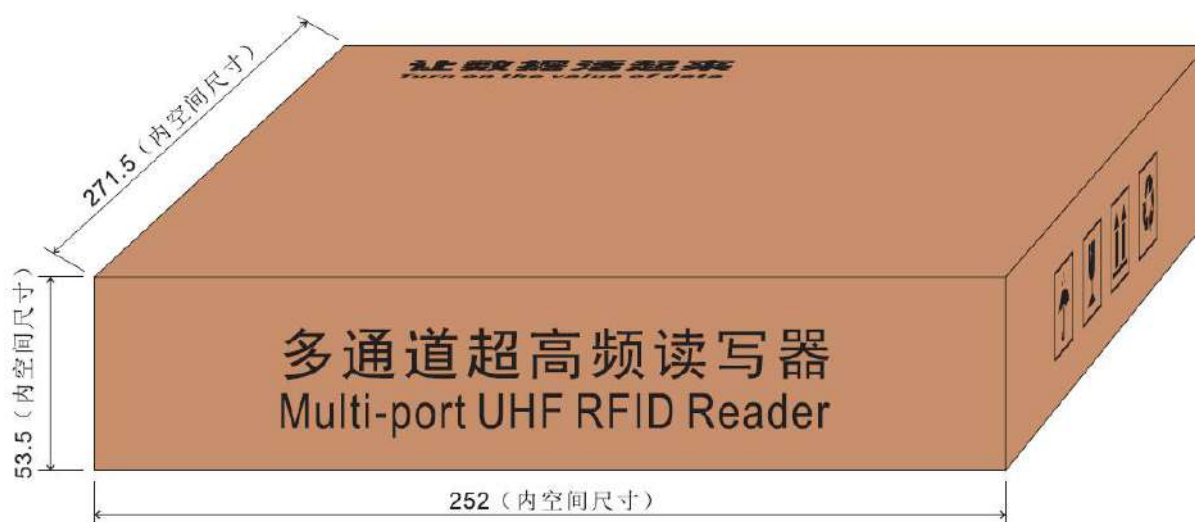

Figure 6-1 Carton box size

Carton box size: 252mm*271.5mm*53.5mm (inner size)

7.2 Accessories

In order to facilitate future storage and transportation, after unpacking the Shine 340/380 reader, properly store the box and packaging materials. In addition to the reader, the box also includes the accessories required for the use of the product. Please confirm whether the product and accessories are complete according to the product packing list. If there is any discrepancy or damage, please contact the after-sales service in time. The specific packing list is shown in Table 6-1:

Table 6-1 Packing list

No	Name	Unit	Quantity	Remarks
1	Shine 340/380	1	Set	Included
2	Power adapter 24V/2.5A	1	Pcs	Included
3	AC power cord	1	Pcs	Included
4	LAN Cable	1	Pcs	Included
5	USB type-c cable	1	Pcs	Included

6	Mounting screws M4*28 nickel plated	4	Pcs	Included
7	warranty card	1	Pcs	Included
8	Certificate of approval	1	Pcs	Included
9	10P GPIO connector	2	Pcs	Included
10	Foot pad	4	Pcs	Included
11	4G antenna	2	Pcs	Included
12	Bluetooth WIFI antenna	1	Pcs	Included

7.3 Storage Requirements

Shine 340/380 reader should be stored in below conditions:

- ✧ Environmental temperature: $-40^{\circ}\text{C} \sim +85^{\circ}\text{C}$
- ✧ Relative humidity: 5% RH \sim 90%RH

8. After-sale Service

Letter to Customers

Since our aim is to continuously improve our products for better user experience, we may modify the product characteristics, composition and design of circuits without given notifications. Thus the real product may be not in accordance with this manual. Generally, we will provide timely amendments to this manual. If its not provided timely, please consult our service department.

Shenzhen Hopeland Technologies Co., Ltd.

Guarantee card of Shenzhen Hopeland Technologies Co., Ltd

Product Name		Model No.	
Product Code		Level	
Description of troubles			
User's name		Postcode	
Contact Person		Contact No.	

Warranty Description

In order to offer users better service, our company provide warranty card with each device, please keep it to enjoy the service.

- 1, Products can replace free under conditions within one month after sale, in the pre condition of normal operation without repairing.
- 2, Free maintenance won't be given under the following circumstance:
 - ✧The damage of the terminal caused by high voltage of the power grid.
 - ✧The damage caused by misuse or operated improperly.
 - ✧The damage caused by excessive vibration when user delivering.
- 3, The software of this product can be upgraded freely, users can be training in our company for free.
- 4, Will be charge appropriately if the user don't have a warranty card.
- 5, Users will need to fill out the warranty card for repair service, and sent back to Hopeland.